

SikaSeal-632 Fire Putty+

DECLARATION OF PERFORMANCE

No. 30816702

1	UNIQUE IDENTIFICATION CODE OF THE PRODUCT-TYPE:	30816702
2	INTENDED USE/S	EAD 350454-00-1104:2017 Fire Stopping and Sealing Product: Penetration Seals
3	MANUFACTURER:	Sika Services AG Tüffenwies 16-22 8064 Zürich
4	AUTHORISED REPRESENTATIVE:	-
5	SYSTEM/S OF AVCP:	System 1
6b	EUROPEAN ASSESSMENT DOCUMENT:	EAD 350454-00-1104:2017
	European Technical Assessment:	ETA-21/1029 of 2021/11/25
	Technical Assessment Body:	ETA-DANMARK A/S
	Notified body/ies:	2531

7 DECLARED PERFORMANCE/S

Essential Characteristics	Performance	AVCP	Harmonised Technical Specification
Reaction to fire	NPD	System 1	
Resistance to fire	Annex A	System 1	
Air permeability	Annex B	System 1	
Water permeability	NPD	System 1	
Content, emission and/or release of dangerous substances	NPD	System 1	
Mechanical resistance and stability	NPD	System 1	EAD 350454-00-1104:2017
Resistance to impact/movement	NPD	System 1	
Adhesion	NPD	System 1	
Durability	Z ₂	System 1	
Airborne sound insulation at 25 mm depth	R _w (C;Ctr)= 67 (-2;-7) dB*	System 1	
Thermal properties	NPD	System 1	
Water vapour permeability	NPD	System 1	

*Applicable only for SikaSeal-632 Fire Putty+ Pads in socket boxes

ANNEX A – RESISTANCE TO FIRE CLASSIFICATION – SIKASEAL-632 FIRE PUTTY+

A.1 Flexible wall constructions with wall thickness of minimum 100 mm

A.1.1 Pipe and cable penetration seals with 4 mm thick SikaSeal-632 Fire Putty+ in socket box

Penetration Seal: Socket boxes with 15 mm long SikaSeal-632 Fire Putty+ wrapped around the pipe protrusion from the socket box. Min. 30 mm between cable penetrations.

Construction details:

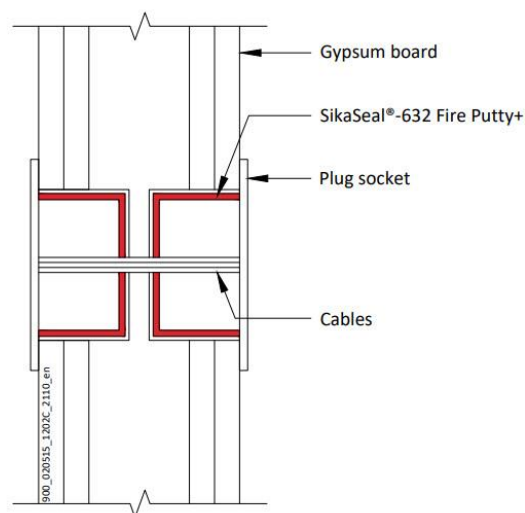
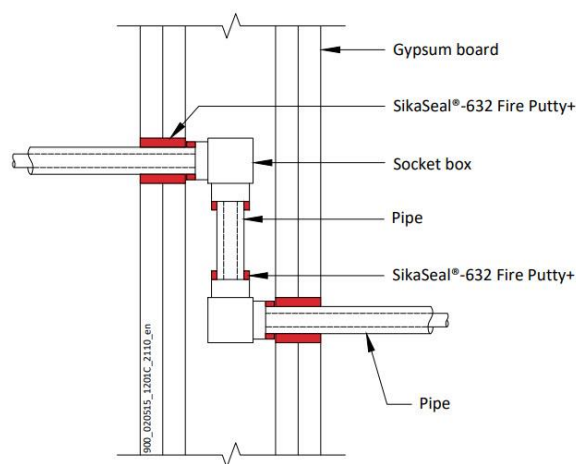

A.1.1.1 Double side penetration seal with pipes in socket boxes

Services	Socket box	SikaSeal-632 Fire Putty+ - mm	Aperture mm	Classification
Høiax 25mm PEX pipe in pipe hose	Single or double Høiax Push Wallbox 15mm*	174 x 64 x 4 mm pad around pipe / 50 Ø x 25 mm at back of the box	63 Ø	EI 90
Cables up to 14 mm diameter	UK standard double socket box, maximum 130mm wide x 70mm high x 47mm deep, each with up to 22mm hole cut to accept the cables	Interior of box fully lined with pad	Maximum 135 wide x 75 high	EI 60

*Fixed directly to studs or with steel plate between studs.

A.1.2 Cable penetration seals with 4 mm thick SikaSeal-632 Fire Putty+ in socket box

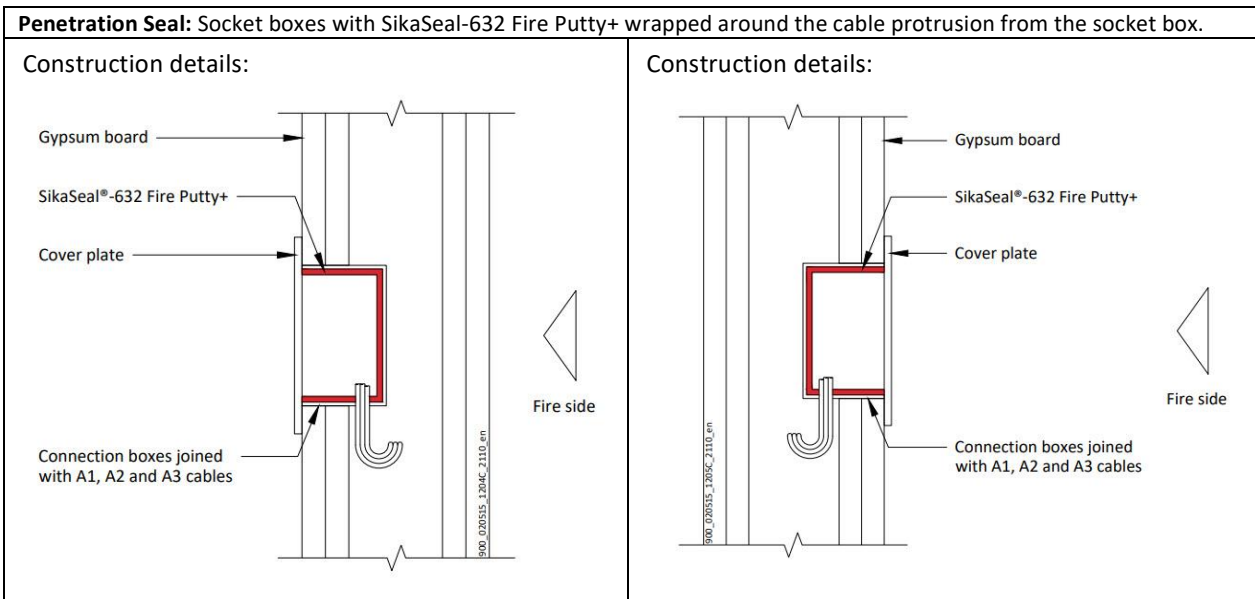

A.1.2.1 Single side penetration seal with cables in socket boxes

Services	Socket box	SikaSeal-632 Fire Putty+	Position	Aperture mm	Classification
Cables up to 14 mm diameter	Schneider Electric Ref. IMT 36026 connection box, 72mm wide x 90mm high x 50mm deep	Fitted lining the back of the back box	Side by side – 1 fitted to each face, or separated	73 wide x 91 High x 51 deep	E 60, EI 45
Cables up to 14 mm diameter	Elko 4189 1223720 connection box, 72mm wide x 90mm high x 58mm deep	Interior of box fully lined with pad	Adjacent – 1 fitted to each face, or separated	92 wide x 112 High	EI 90
Cables up to 14 mm diameter	ELKO 5421 123740 connection box, 73mm wide x 73mm high x 55mm deep	Interior of box fully lined with pad	Side by side – 1 fitted to each face, or separated	74 wide x 74 High	EI 90

A.1.3 Double sided penetration seal with cables

Penetration Seal: Cables (single or bundled up to 50 mm \varnothing) penetrating through a flexible or rigid wall construction and fitted at any position within the aperture, sealed with a 15mm diameter cord of SikaSeal-632 Fire Putty+ on both sides of the wall. Maximum annular space 10 mm (A1) and minimum separation between penetration seals 30 mm (A2).

Construction details:

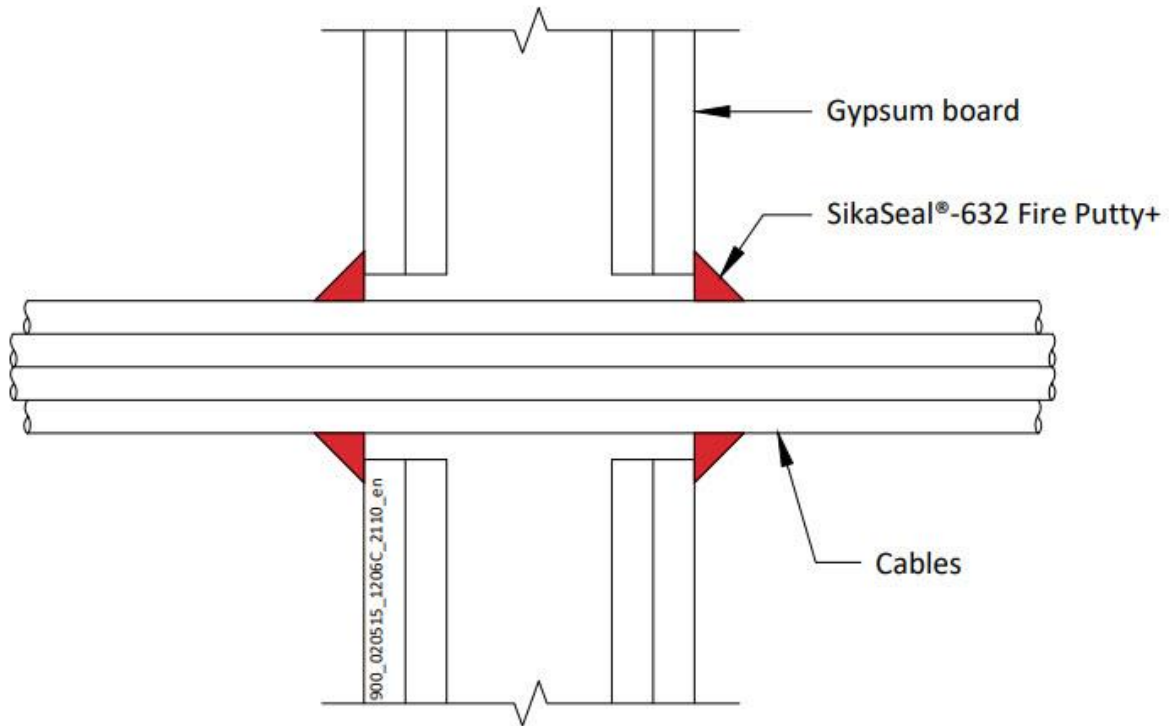

A.1.3.1

Services	Classification
Blank seal with a 15 mm deep cord of SikaSeal-632 Fire Putty+ on both sides of the wall	EI 120
Cables up to 21 mm diameter, single or in a bundle up to 50 mm diameter*	EI 120
Cables up to 80 mm diameter, single or in a bundle up to 50 mm diameter*	EI 60

* Cable specification from EN 1366-3 standard cable configuration

A.1.4 Double sided penetration seal with metallic pipes

Penetration Seal: Metallic pipes penetrating through a flexible or rigid wall construction and fitted at any position within the aperture, sealed with a 15mm diameter cord of SikaSeal-632 Fire Putty+ on both sides of the wall. Maximum annular space 10 mm (A1) and minimum separation between penetration seals 30 mm (A2).

Construction details:

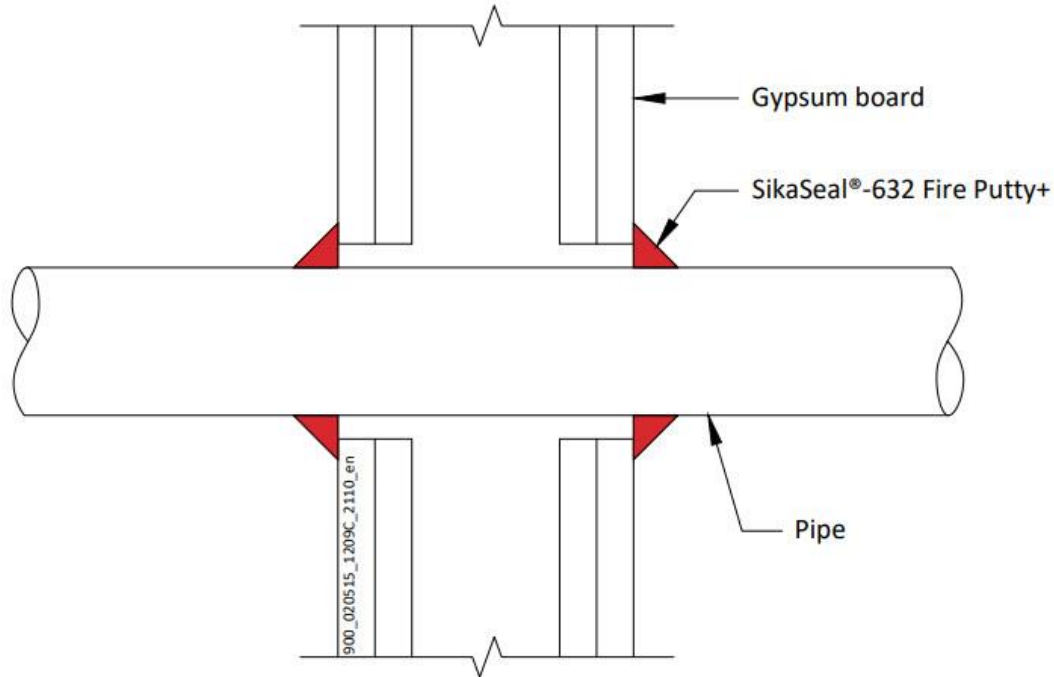

A.1.4.1

Services	Insulation	Classification
Mild or stainless steel pipe		
Maximum 22 mm diameter*	None needed	EI 120 C/U
23-30 mm diameter*	None needed	E 120, EI 45 C/U
ALUPEX pipe		
16 mm diameter*	None needed	EI 120 C/C
17-20 mm diameter*	None needed	E 120, EI 90 C/C
Copper or steel pipe		
6 mm diameter*	None needed	EI 120 C/C
7-12 mm diameter*	None needed	E 120, EI 60 C/C

*See below graphs for interpolation pipe sizes

Declaration of Performance

SikaSeal-632 Fire Putty+
30816702
2021.12 , ver. 1
1549

Template for translation. Only for
internal use

Mild or Stainless Steel Pipes - EI 120 C/C

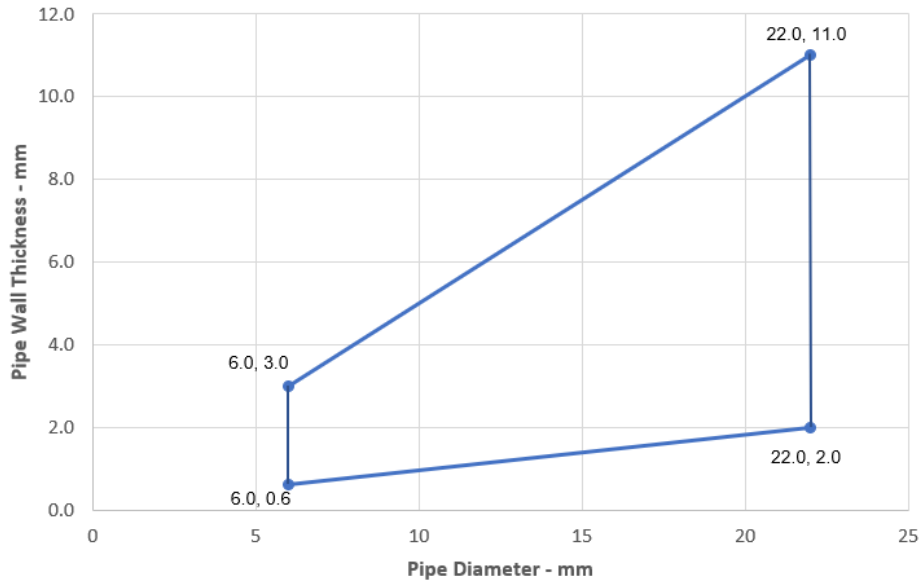

Steel Pipes - E 120, EI 45 C/U

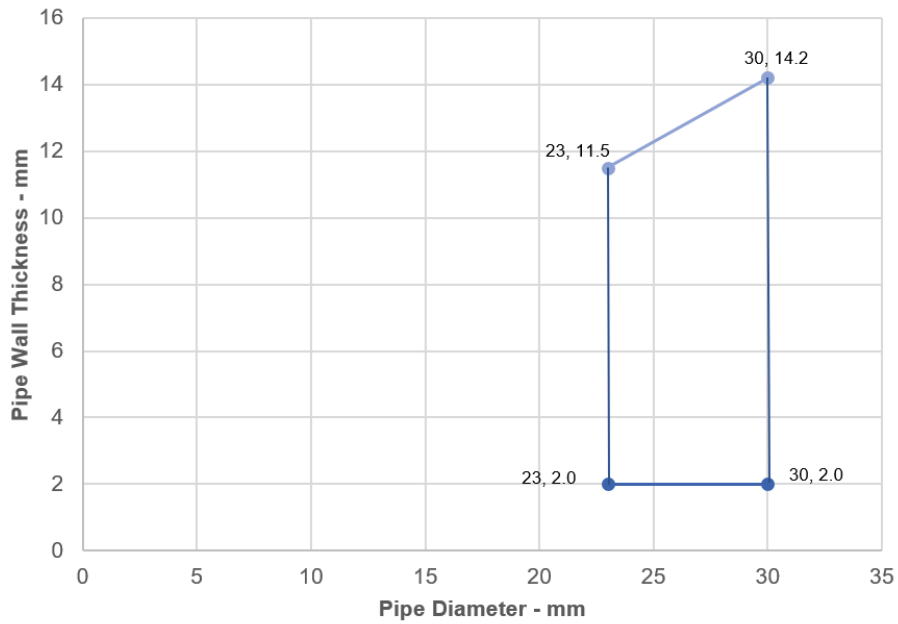

Declaration of Performance
 SikaSeal-632 Fire Putty+
 30816702
 2021.12 , ver. 1
 1549

Template for translation. Only for
 internal use

ALUPEX Pipes - E 120, EI 90 C/C

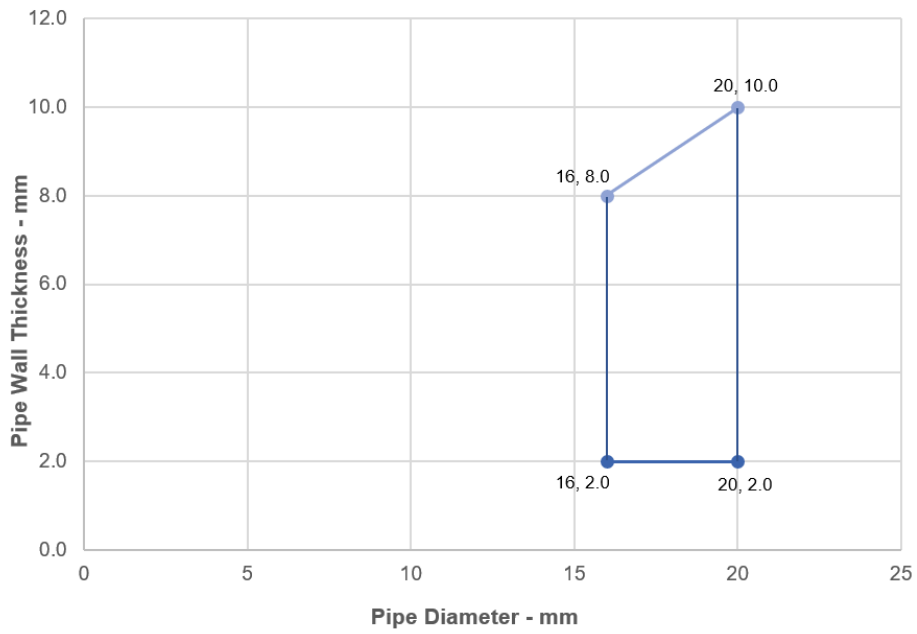

Copper Pipes- E120, EI 60 C/C

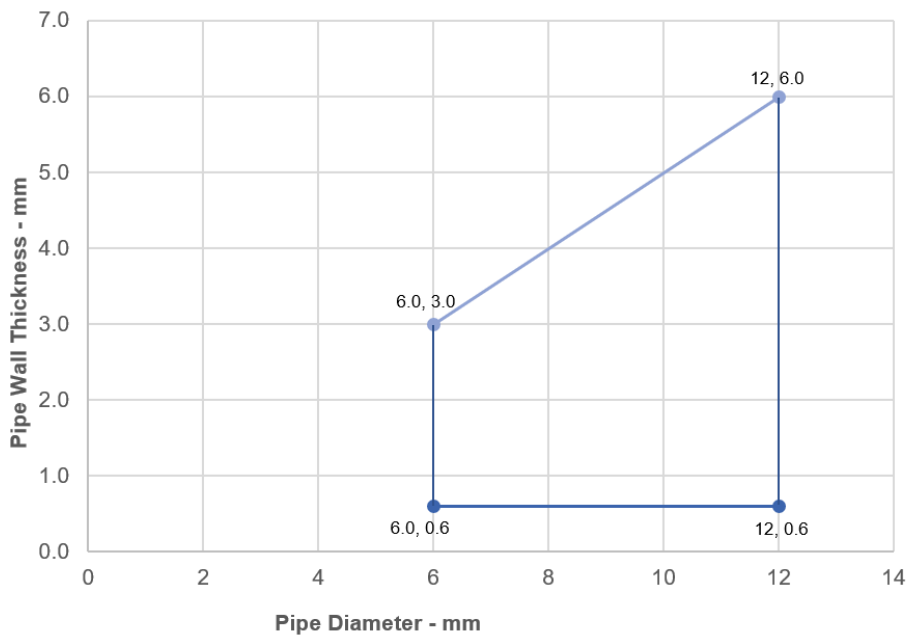

Declaration of Performance
SikaSeal-632 Fire Putty+
30816702
2021.12 , ver. 1
1549

Template for translation. Only for
internal use

A.1.5 Double sided penetration seal with insulated metallic pipes, Local Interrupted (LI)

Penetration Seal: Metallic pipes insulated with minimum 80 kg/m³ density mineral wool insulation, Local Interrupted (LI), penetrating through a flexible or rigid wall construction, fitted at any position within the aperture, sealed with a 15mm diameter cord of SikaSeal-632 Fire Putty+ on both sides of the wall. Maximum annular space 10 mm (A1) and minimum separation between penetration seals 30 mm (A2).

Construction details:

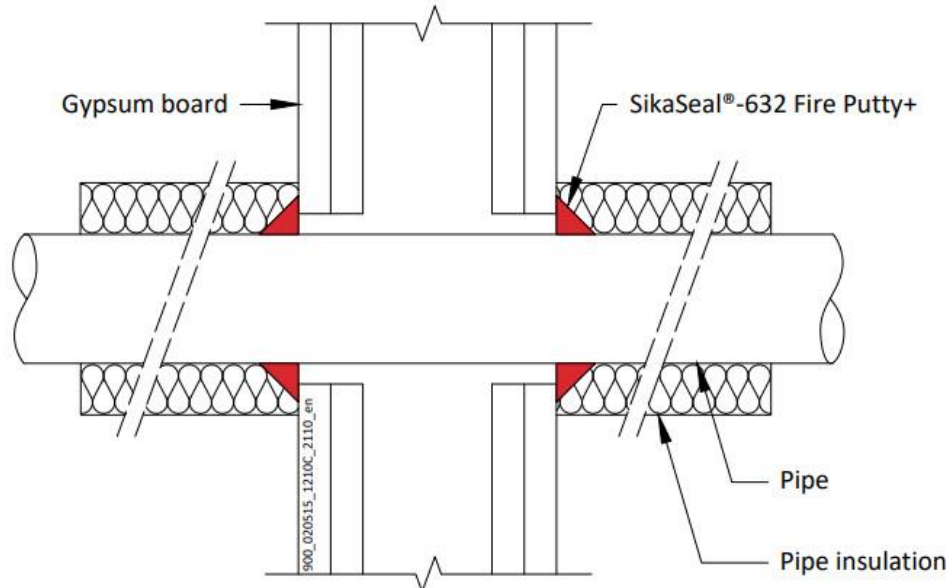

A.1.5.1

Services	Insulation	Classification
Mild or stainless steel pipe, with minimum 80 kg/m ³ density mineral wool insulation		
Maximum 40 mm diameter*	Minimum 20 mm thick insulation, 500 mm long butted up to the wall on both faces	EI 120 C/U
40-324 mm diameter*	Minimum 30 mm thick insulation, 500 mm long butted up to the wall on both faces	EI 120 C/U
Copper or steel pipe with minimum 80 kg/m ³ density mineral wool insulation		
Maximum 54 mm diameter/1.2-14.2 mm wall	Minimum 20 mm thick insulation, 500 mm long butted up to the wall on both faces	E 90, EI 60 C/C
ALUPEX pipe with minimum 80 kg/m ³ density mineral wool insulation		
Maximum 16 mm diameter*	Minimum 20 mm thick insulation, 500 mm long butted up to the wall on both faces	EI 90 C/C
Maximum 75 mm diameter*	Minimum 30 mm thick insulation, 500 mm long butted up to the wall on both faces	EI 90 C/C

*See below graphs for interpolation pipe sizes

Declaration of Performance

SikaSeal-632 Fire Putty+
30816702
2021.12, ver. 1
1549

Template for translation. Only for internal use

Steel Pipes with 30 mm Thick Insulation - EI 120, C/U

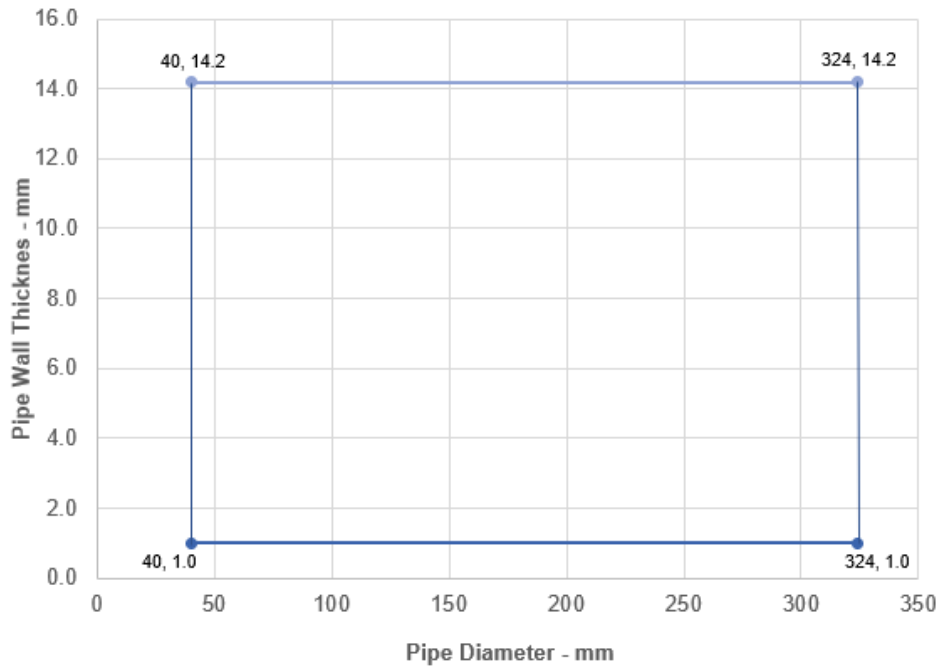

ALUPEX Pipes with 30 mm Thick Insulation - EI 90 C/C

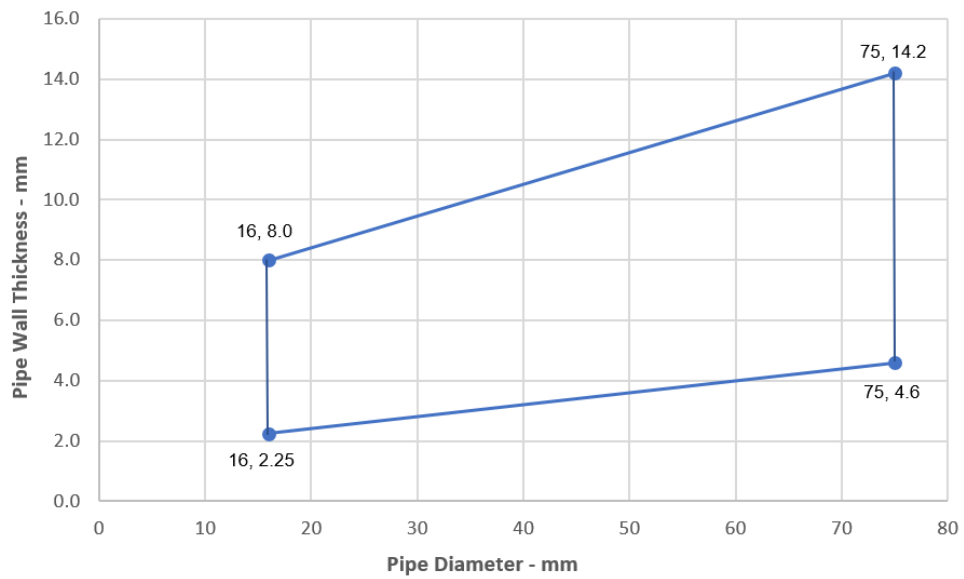

A.1.6 Double sided penetration seal with insulated metallic pipes, Continuous Sustained (CS)

Penetration Seal: Metallic pipes insulated with minimum 80 kg/m³ density mineral wool insulation, Continuous Sustained (CS), penetrating through a flexible or rigid wall construction, fitted at any position within the aperture, sealed with a 15mm diameter cord of SikaSeal-632 Fire Putty+ on both sides of the wall. Maximum annular space 10 mm (A1) and minimum separation between penetration seals 30 mm (A2).

Construction details:

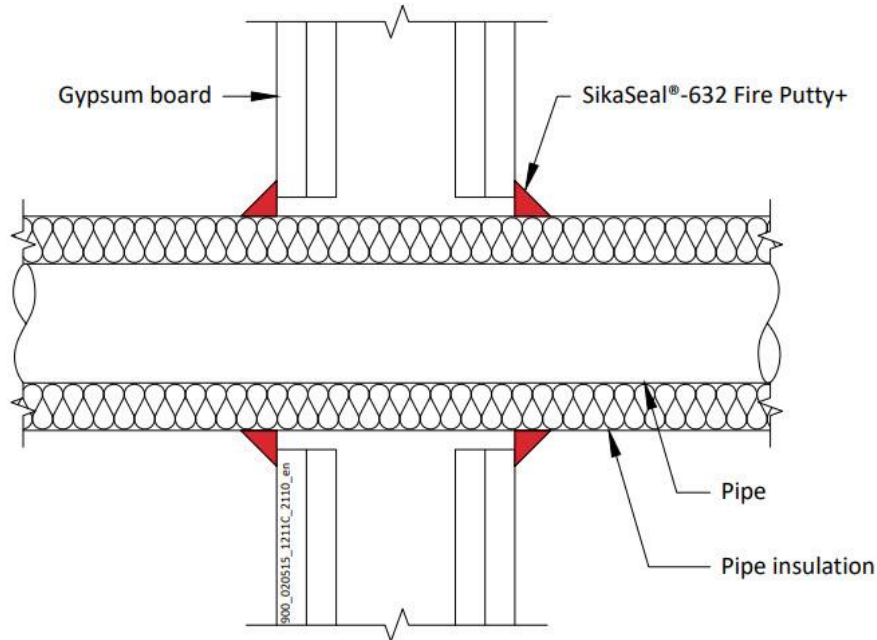

A.1.6.1

Services	Insulation	Classification
Mild or stainless steel pipe, with minimum 80 kg/m ³ density mineral wool insulation		
Maximum 40 mm diameter*	20 mm thick	EI 120 C/U
40-324 mm diameter*	30-80 mm thick	E 90, EI 60 C/U
Copper or steel pipe with minimum 80 kg/m ³ density mineral wool insulation		
Maximum 12 mm diameter/0.7-6.0 mm wall*	20 mm thick	E90, EI 60 C/C
Maximum 54 mm diameter/1.2-14.2 mm wall,	30-80 mm thick	E 90, EI 60 C/C
ALUPEX pipe with minimum 80 kg/m ³ density mineral wool insulation		
Maximum 16 mm diameter*	20 mm thick	EI 90 C/C
Maximum 75 mm diameter*	30-80 mm thick	EI 90 C/C

*See below graphs for interpolation pipe sizes

Declaration of Performance

SikaSeal-632 Fire Putty+
30816702
2021.12, ver. 1
1549

Template for translation. Only for
internal use

Steel Pipes with 30-80 mm Thick Insulation- E 90, EI 60, C/U

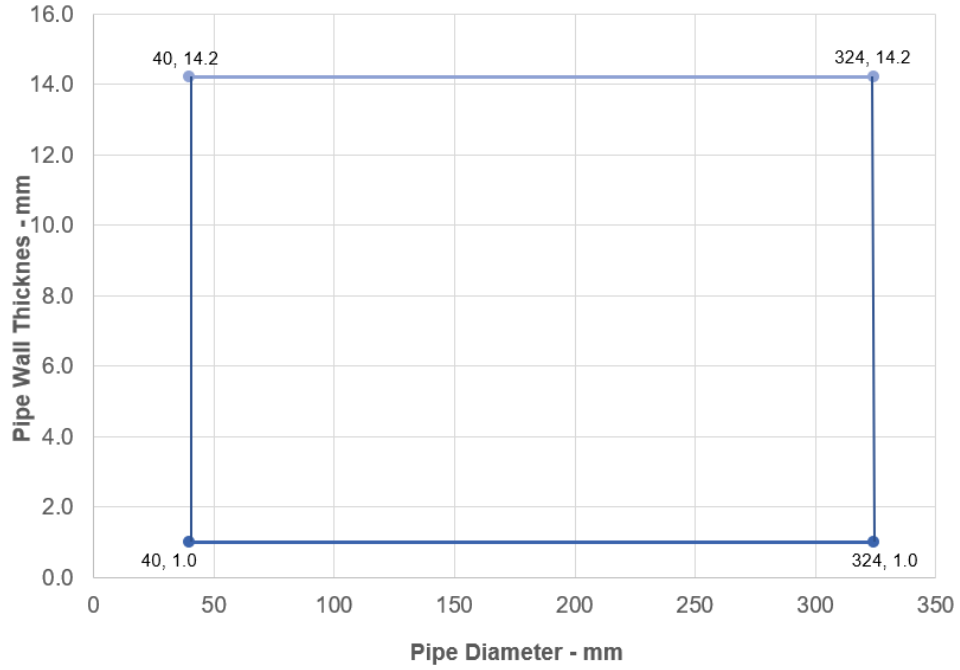

**Copper or Steel Pipes with 30-80 mm Thick Insulation
E 90, EI 60, C/C**

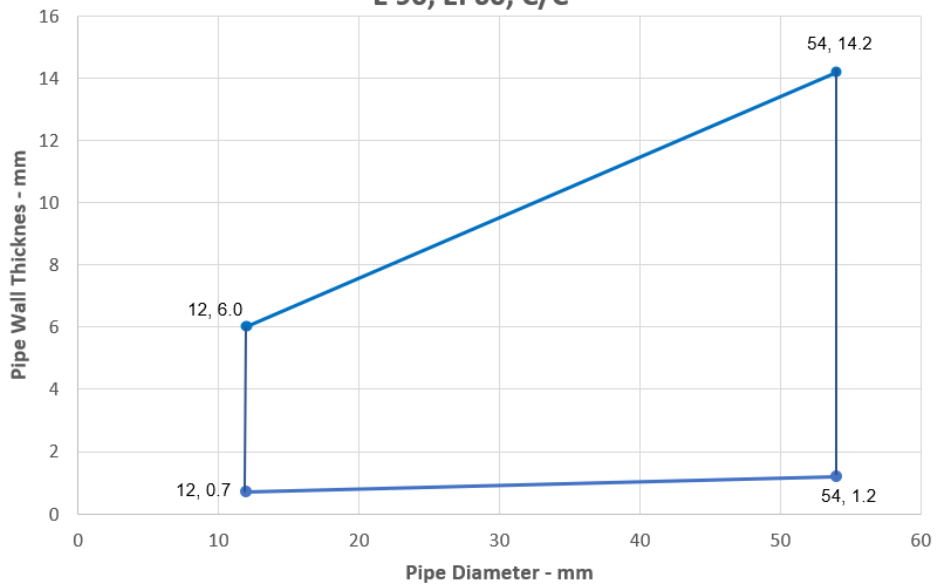

ALUPEX Pipes with 30-80 mm Thick Insulation - EI 90 C/C

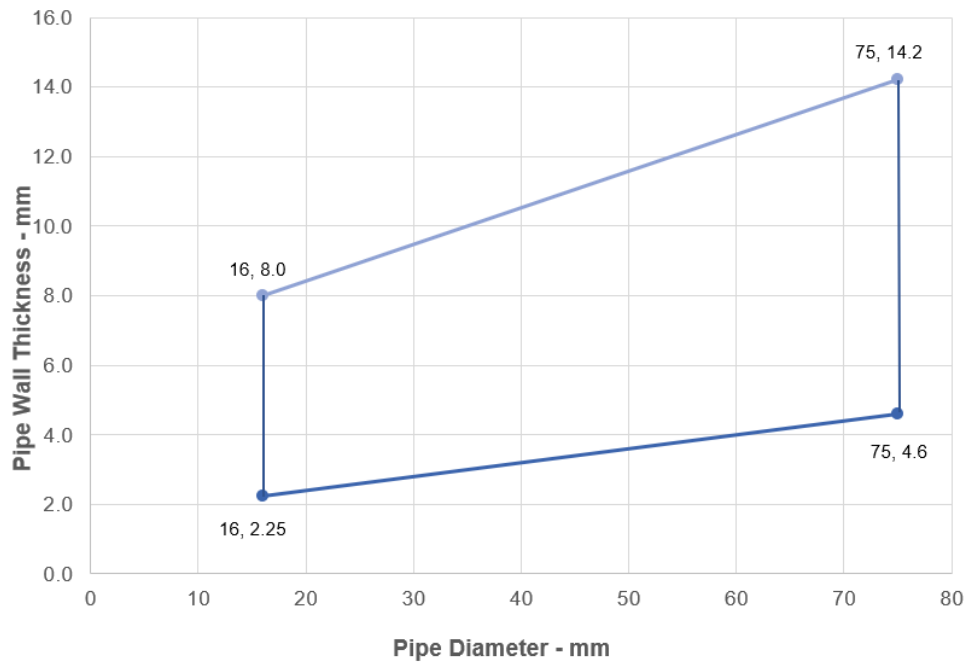

Declaration of Performance
SikaSeal-632 Fire Putty+
30816702
2021.12 , ver. 1
1549

Template for translation. Only for
internal use



A.2 Flexible wall constructions with wall thickness of minimum 120 mm

A.2.1 Cable penetration seals with 4 mm thick SikaSeal-632 Fire Putty+ in socket box

Penetration Seal: Socket boxes with SikaSeal-632 Fire Putty+ wrapped around the cable protrusion from the socket box.

Construction details:

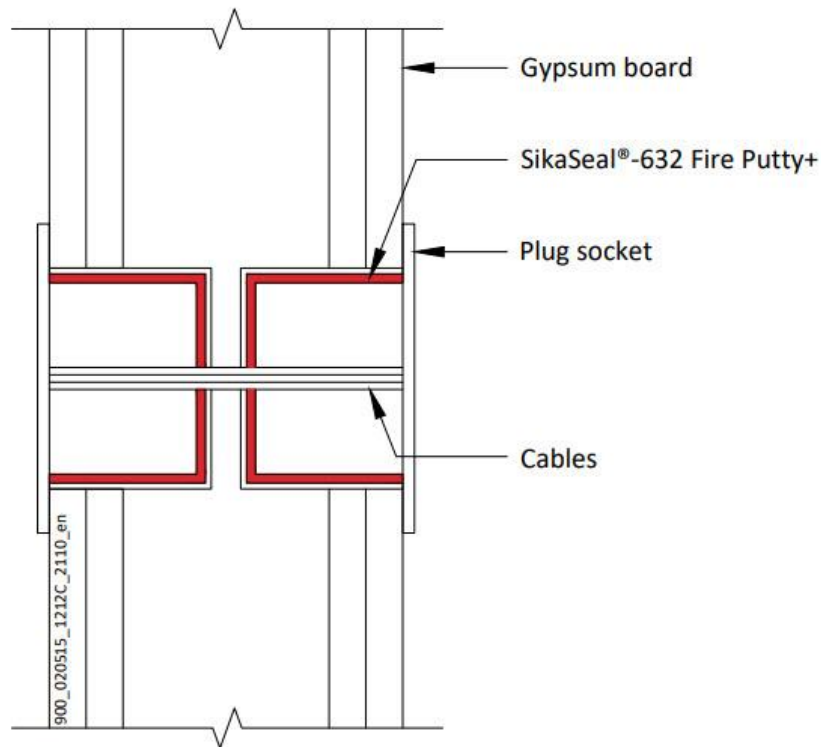

A.2.1.1 Double side penetration seal with cables in socket boxes

Services	Socket box	SikaSeal-632 Fire Putty+	Position	Aperture mm	Classification
Cables up to 14 mm diameter	UK standard double socket box, maximum 130mm wide x 70mm high x 48mm deep, each with a 25mm wide x 14mm high knock out section centrally located at the bottom back angle of the box to accept the cables	Interior of box fully lined with pad	Back to back – 1 fitted to each face, or separated	Maximum 135 wide x 72 High	EI 120
2.5 mm twin and earth cables					

A.2.2 Double sided penetration seal with metallic pipes

Penetration Seal: Metallic pipes penetrating through a flexible or rigid wall construction and fitted at any position within the aperture, sealed with a 15mm diameter cord of SikaSeal-632 Fire Putty+ on both sides of the wall. Maximum annular space 10 mm (A1) and minimum separation between penetration seals 30 mm (A2).

Construction details:

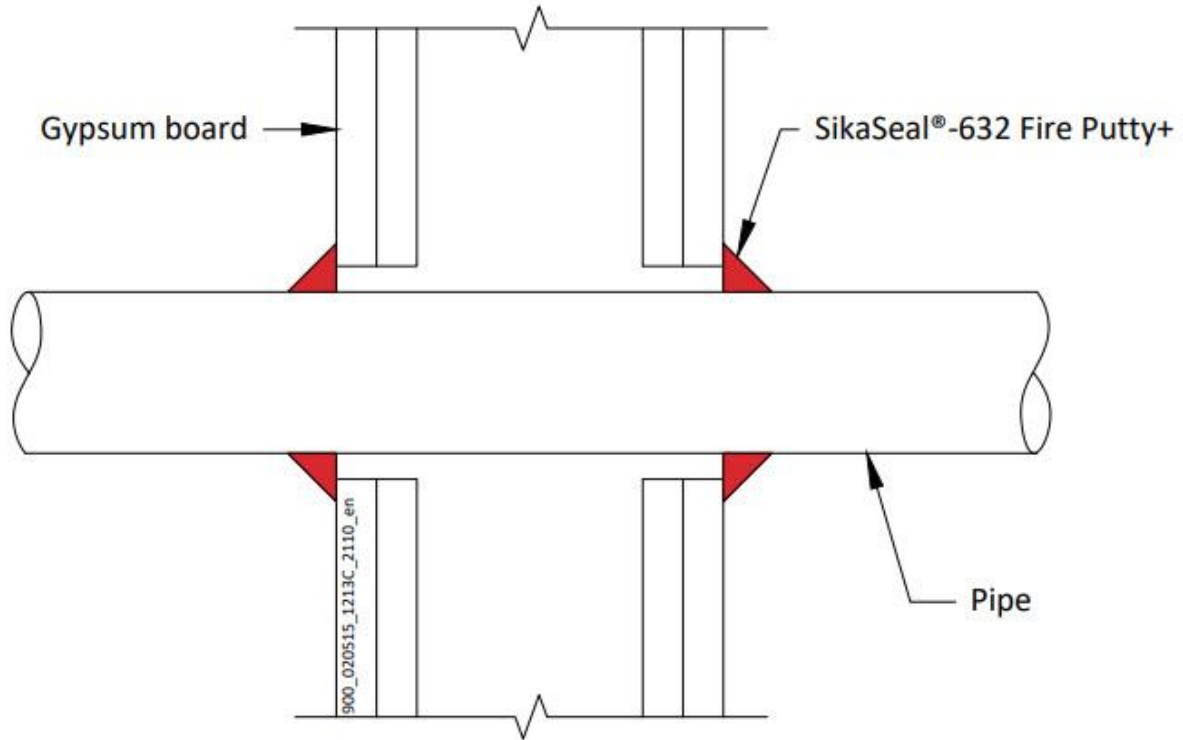

A.2.2.1

Services	Insulation	Classification
Mild or stainless steel pipe		
Maximum 324 mm diameter/6.35-14.2 mm wall	None needed	E 90, EI 20 C/U
ALUPEX pipe		
Maximum 75 mm diameter/4.6-14.2 mm wall	None needed	EI 90 C/C
Copper or steel pipe		
Maximum 54 mm diameter/1.2-14.2 mm wall	None needed	E 90, EI 15 C/C

Declaration of Performance

SikaSeal-632 Fire Putty+
30816702
2021.12 , ver. 1
1549

Template for translation. Only for internal use

A.3 Rigid wall constructions with wall thickness of minimum 150 mm

A.3.1 Double sided penetration seal with insulated metallic pipes, Continuous Sustained (CS)

Penetration Seal: Metallic pipes insulated with minimum 80 kg/m³ density mineral wool insulation, Continuous Sustained (CS), penetrating through a rigid wall construction, fitted at any position within the aperture, sealed with a 15mm diameter cord of SikaSeal-632 Fire Putty+ on both sides of the wall. Maximum annular space 10 mm (A1) and minimum separation between penetration seals 30 mm (A2).

Construction details:

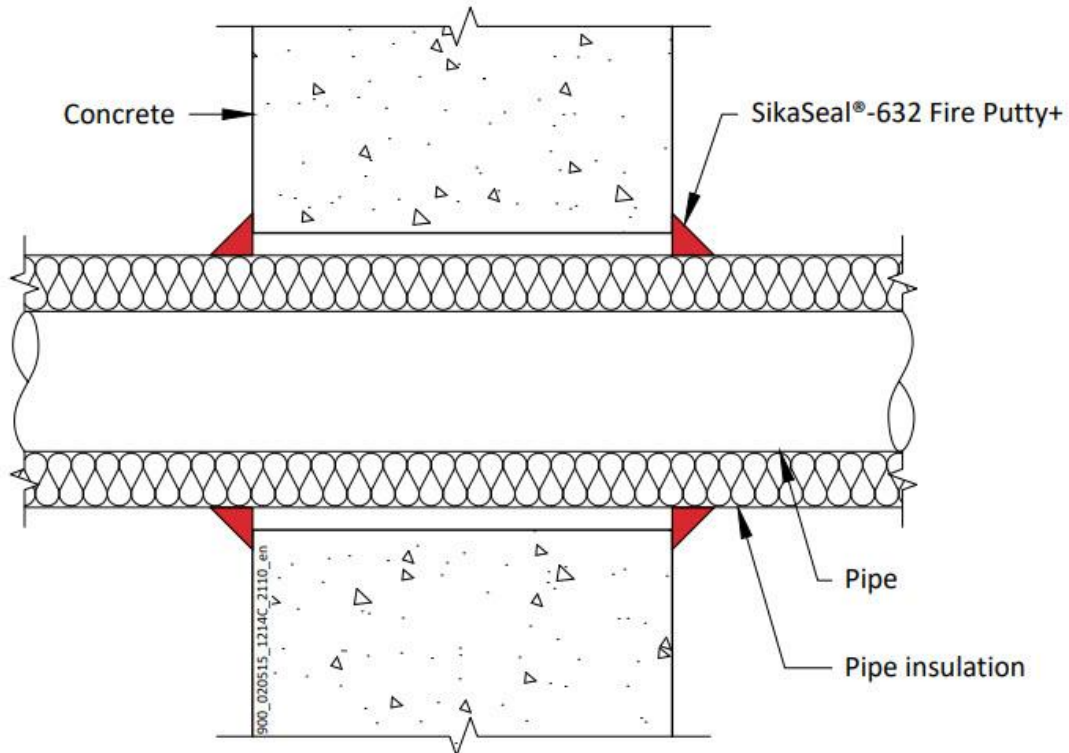

A.3.1.1

Services	Insulation	Classification
Mild or stainless steel pipe, with minimum 80 kg/m ³ density mineral wool insulation		
Maximum 40 mm diameter*	20 mm thick	EI 120 C/U
Maximum 324 mm diameter*	30-80 mm thick	E 240, EI 180 C/U
Copper or steel pipe with minimum 80 kg/m ³ density mineral wool insulation		
Maximum 54 mm diameter/1.2-14.2 mm wall	20 mm thick	E 240, EI 120 C/C
ALUPEX pipe with minimum 80 kg/m ³ density mineral wool insulation		
Maximum 16 mm diameter*	20 mm thick	EI 240 C/C
Maximum 75 mm diameter*	30 mm thick	EI 240 C/C

*See below graphs for interpolation pipe sizes

Declaration of Performance

SikaSeal-632 Fire Putty+
30816702
2021.12, ver. 1
1549

Template for translation. Only for
internal use

**Mild or Stainless Pipes with 30-80 mm Thick Insulation
E 240, EI 180 C/U**

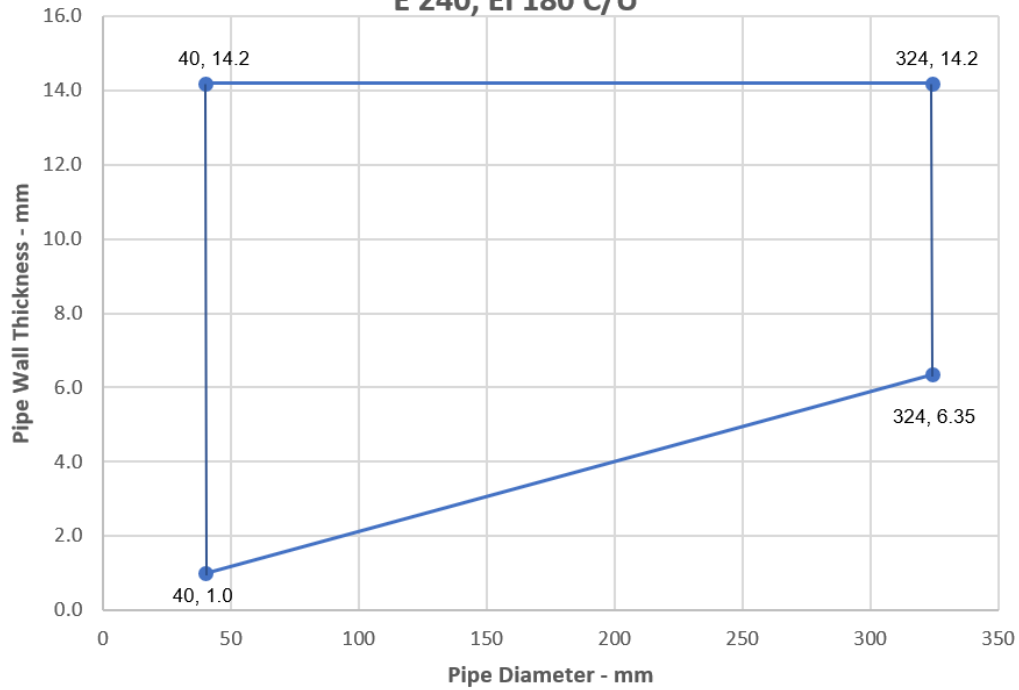

ALUPEX Pipes with 30 mm Thick Insulation - EI 240 C/C

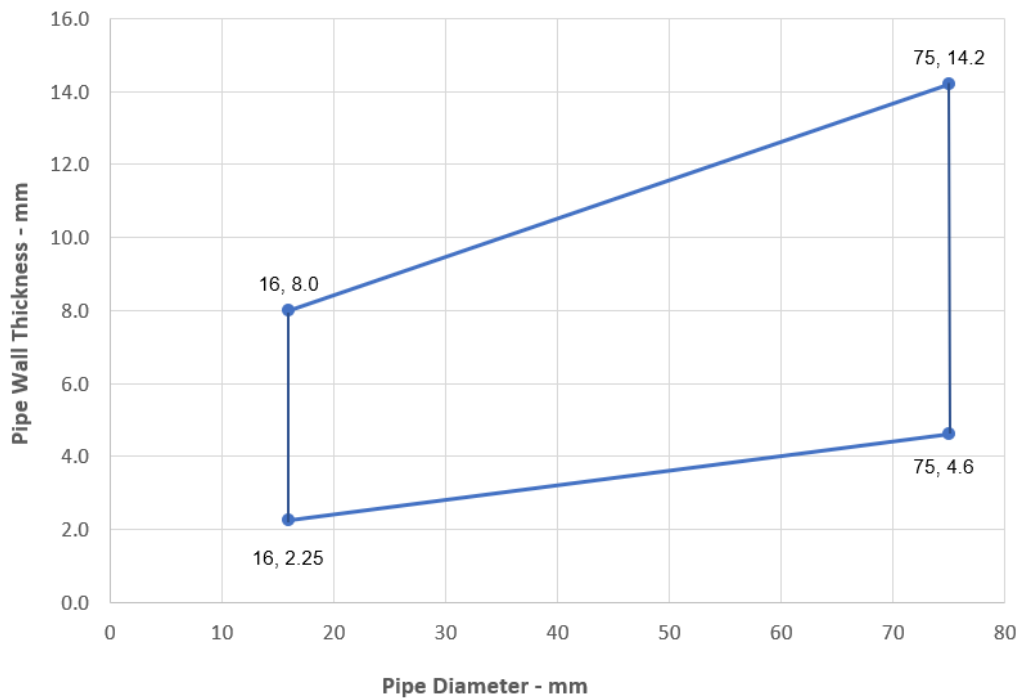

Declaration of Performance
SikaSeal-632 Fire Putty+
30816702
2021.12 , ver. 1
1549

Template for translation. Only for
internal use

A.4 Rigid floor constructions with floor thickness of minimum 150 mm

A.4.1 Single sided penetration seal with cables

Penetration Seal: Cables (single or bundled up to 50 mm \varnothing) penetrating through a rigid floor construction and fitted at any position within the aperture, sealed with a 15mm diameter cord of SikaSeal-632 Fire Putty+ on the top face of the floor. Maximum annular space 10 mm (A1) and minimum separation between penetration seals 30 mm (A2). When incorporating blank penetration seals, the aperture is sealed with 15mm wide by 15mm thick cord of SikaSeal-632 Fire Putty+, applied flush with the bottom face of the floor.

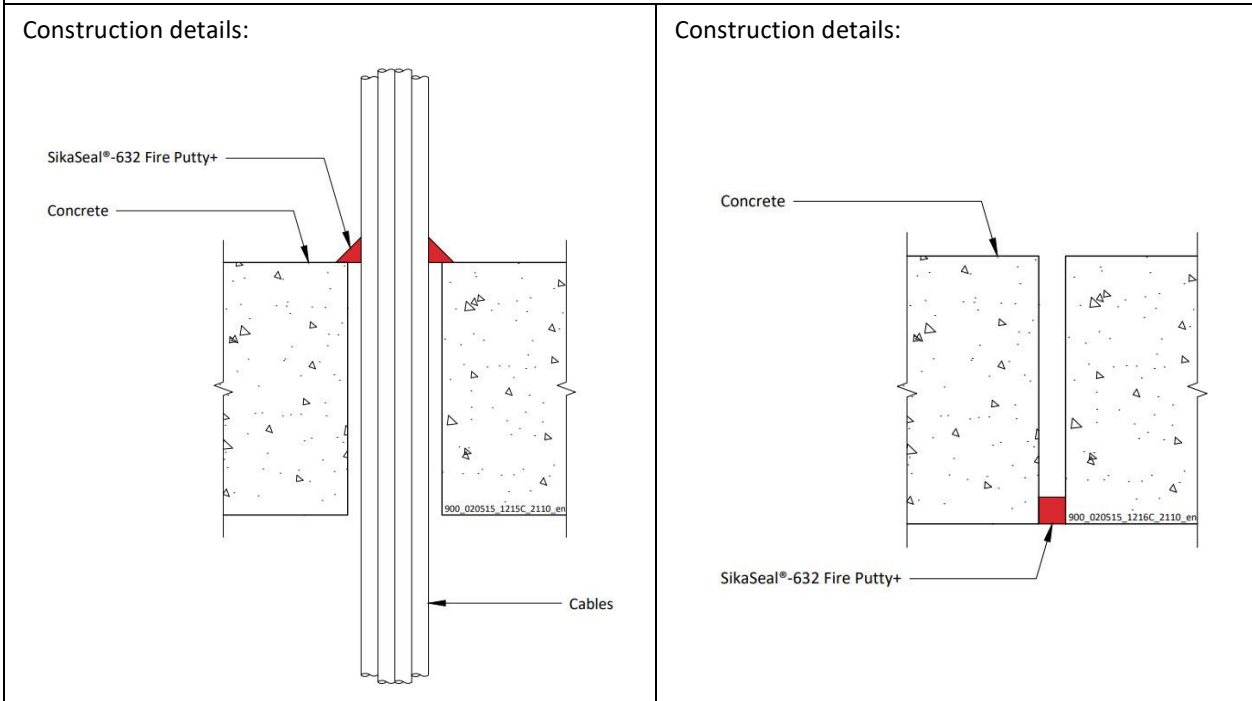

A.4.1.1

Services	Classification
None (blank)	E 120, EI 30
Cables up to 21 mm diameter in tied bundles up to 50 mm diameter*	E 120, EI 60
Cables up to 21 mm diameter*	EI 120
Cables 22-50 mm diameter*	E 120, EI 90
Cables 51-80 mm diameter*	E 120, EI 60
Single 'A1' type cable*	EI 240
Single 'C3' type cable*	EI 240
Single 'E' type cable*	EI 120
Single 'D1' type cable*	EI 120
Single 'D2' type cable*	EI 120
Single 'D3' type cable*	E 240, EI 60

* Cable specification from EN 1366-3 standard cable configuration

Declaration of Performance

SikaSeal-632 Fire Putty+
30816702
2021.12, ver. 1
1549

Template for translation. Only for
internal use

A.4.2 Single sided penetration seal with cables

Penetration Seal: Cables (single or bundled up to 75 mm \varnothing) penetrating through a rigid floor construction and fitted at any position within the aperture, sealed with a 15mm diameter cord of SikaSeal-632 Fire Putty+ on the bottom face of the floor. Maximum annular space 10 mm (A1) and minimum separation between penetration seals 30 mm (A2). When incorporating blank penetration seals, the aperture is sealed with 15mm wide by 15mm thick cord of SikaSeal-632 Fire Putty+, applied flush with both faces of the floor.



A.4.2.1

Services	Seal size	Classification
None (blank)	15mm deep	EI 120
Cables up to 21 mm diameter in tied bundles up to 75mm diameter*	15 mm diameter cord	E 60, EI 45
Cables up to 21 mm diameter*		E 120, EI 60
Cables 22-80 mm diameter*		E 90, EI 45

* Cable specification from EN 1366-3 standard cable configuration

Declaration of Performance

SikaSeal-632 Fire Putty+
30816702
2021.12 , ver. 1
1549

Template for translation. Only for
internal use

A.4.3 Double sided penetration seal with cables

Penetration Seal: Cables (single or bundled up to 50 mm Ø) penetrating through a rigid floor construction and fitted at any position within the aperture, sealed with a 15mm diameter cord of SikaSeal-632 Fire Putty+ on both sides of the floor. Maximum annular space 10 mm (A1) and minimum separation between penetration seals 30 mm (A2).

Construction details:

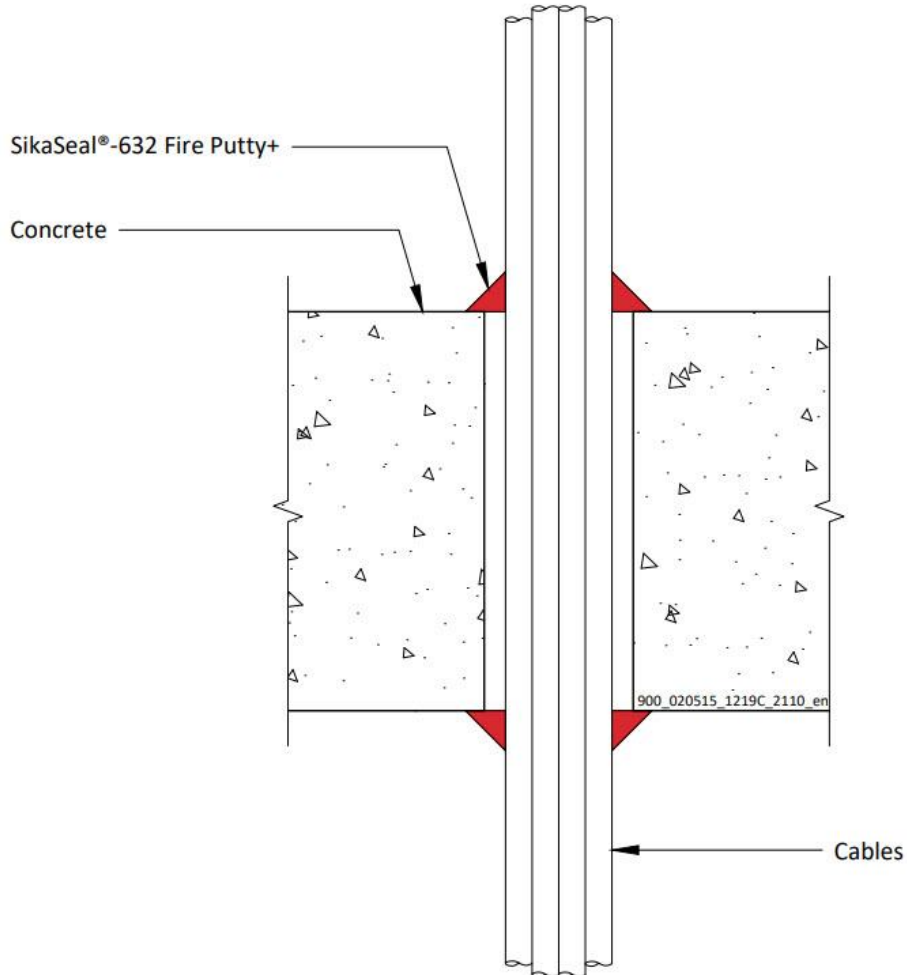

A.4.3.1

Services	Seal size	Classification
Cables up to 21 mm diameter in tied bundles up to 50 mm diameter*	15 mm diameter cord	EI 240

* Cable specification from EN 1366-3 standard cable configuration

Declaration of Performance

SikaSeal-632 Fire Putty+
30816702
2021.12 , ver. 1
1549

Template for translation. Only for
internal use

A.4.4 Single sided penetration seal with metallic pipes

Penetration Seal: Metallic pipes penetrating through a rigid floor construction and fitted at any position within the aperture, sealed with a 15mm diameter cord of SikaSeal-632 Fire Putty+ on the bottom face of the floor. Maximum annular space 10 mm (A1) and minimum separation between penetration seals 30 mm (A2).

Construction details:

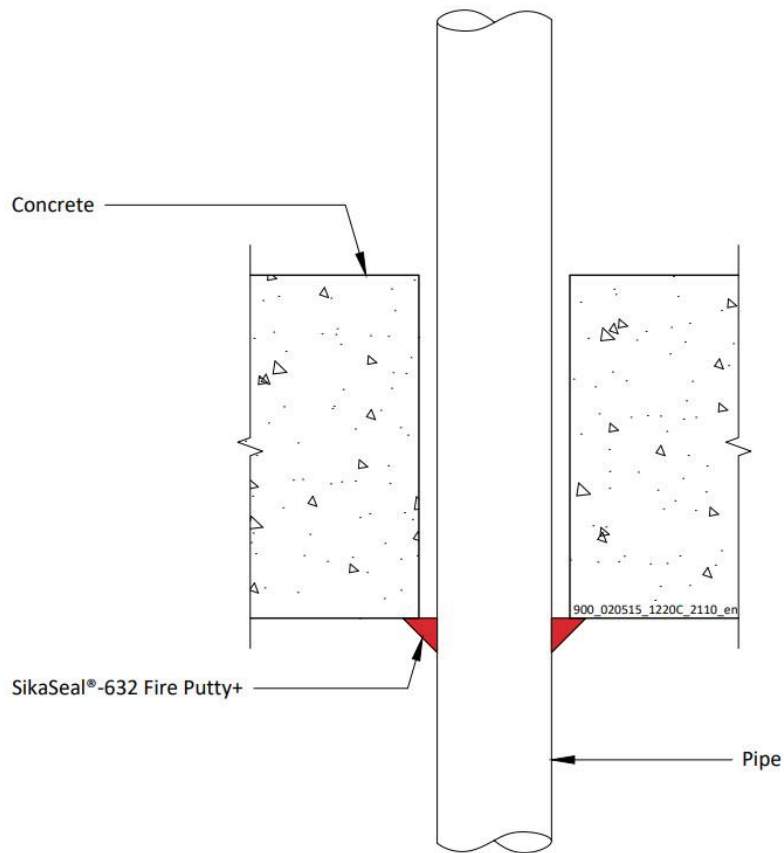

A.4.4.1

Services	Insulation	Classification
Mild or stainless steel pipe		
4 mm diameter*	None needed	EI 120 C/U
5-30 mm diameter*	None needed	E 120, EI 45 C/U
Copper or steel pipe		
6 mm diameter*	None needed	E 120, EI 90 C/C
7-12 mm diameter*	None needed	E 120, EI 30 C/C

*See below graphs for interpolation pipe sizes

Declaration of Performance

SikaSeal-632 Fire Putty+
30816702
2021.12 , ver. 1
1549

Template for translation. Only for
internal use

Steel Pipes - E 120, EI 45 C/U

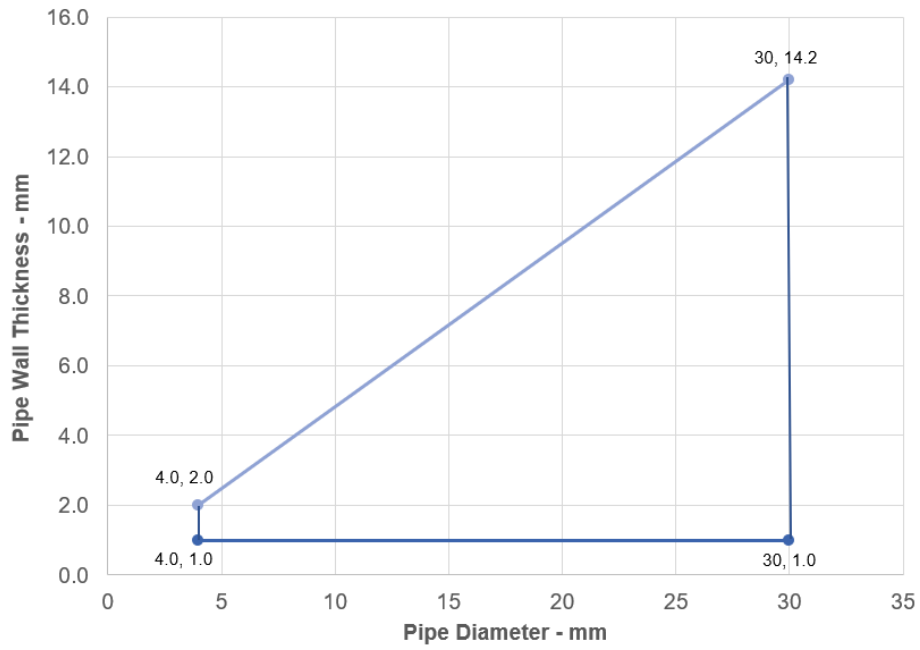

Copper Pipes - E 120, EI 30 C/C

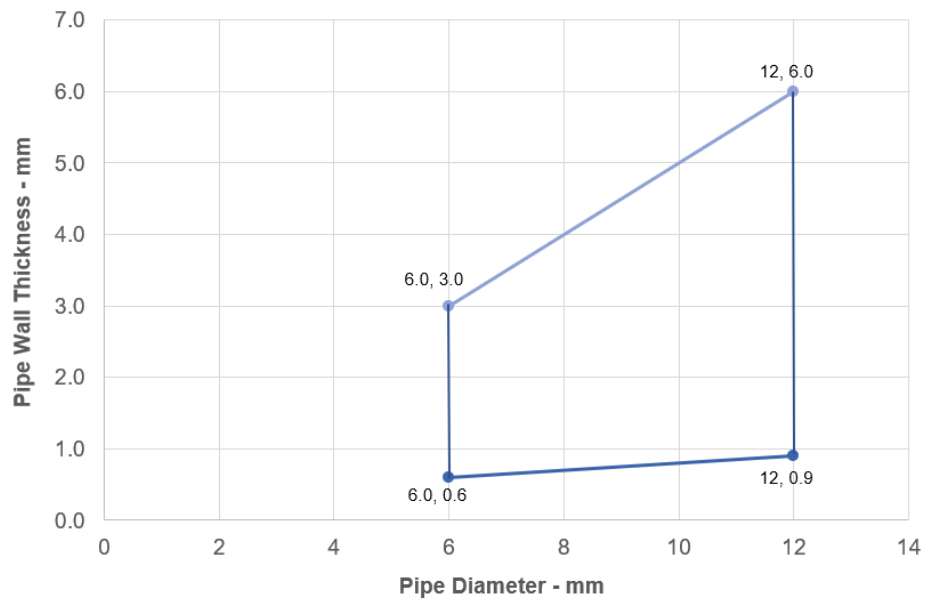

Declaration of Performance
SikaSeal-632 Fire Putty+
30816702
2021.12 , ver. 1
1549

Template for translation. Only for
internal use

A.4.5 Single sided penetration seal with metallic pipes

Penetration Seal: Metallic pipes penetrating through a rigid floor construction and fitted at any position within the aperture, sealed with a 15mm diameter cord of SikaSeal-632 Fire Putty+ on the top face of the floor. Maximum annular space 10 mm (A1) and minimum separation between penetration seals 30 mm (A2).

Construction details:

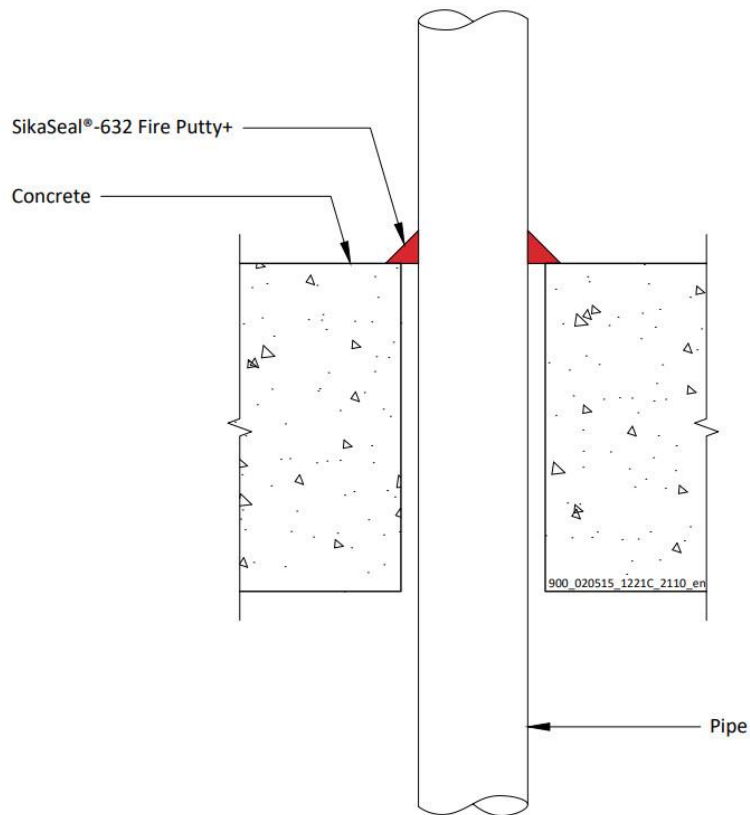

A.4.5.1

Services	Insulation	Classification
Mild or stainless steel pipe		
Maximum 22 mm diameter/1.2-11.0 mm wall*	None needed	EI 120 C/U
Maximum 324 mm diameter/6.35-14.2 mm wall*	None needed	E 240, EI 15 C/U
Copper or steel pipe		
6 mm diameter*	None needed	EI 120 C/C
7-10 mm diameter*	None needed	E 120, EI 90 C/C
Maximum 54 mm diameter/1.2-14.2 mm wall	None needed	E 120 C/C
ALUPEX pipe		
16-20 mm diameter*	None needed	EI 240 C/C
Maximum 75 mm diameter/4.6-14.2 mm wall	None needed	E 45, EI 30 C/C

*See below graphs for interpolation pipe sizes

Declaration of Performance

SikaSeal-632 Fire Putty+
30816702
2021.12 , ver. 1
1549

Template for translation. Only for
internal use

Mild or Stainless Steel Pipes - E 120, EI 15 C/U

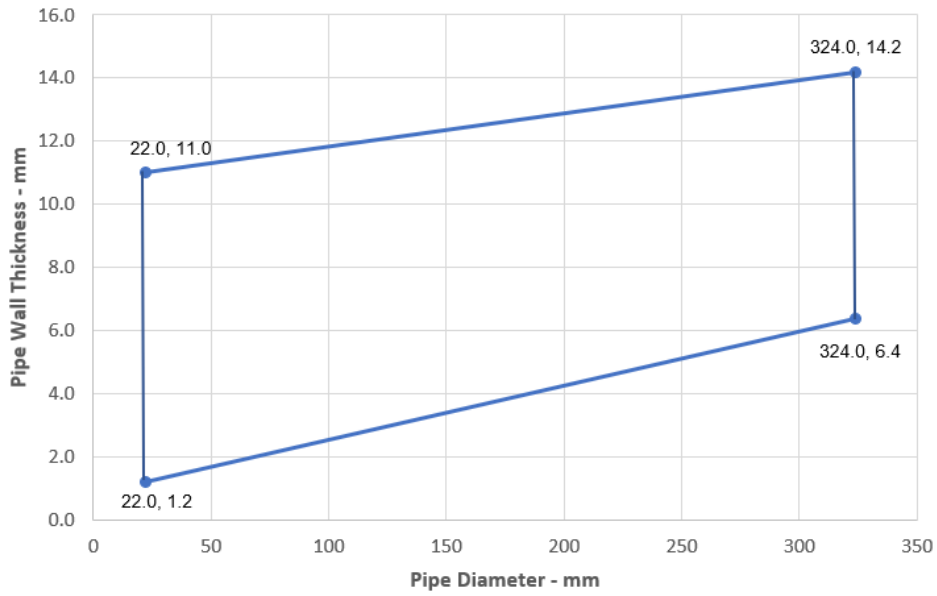

Copper or Steel Pipes - E 120, EI 90 C/C

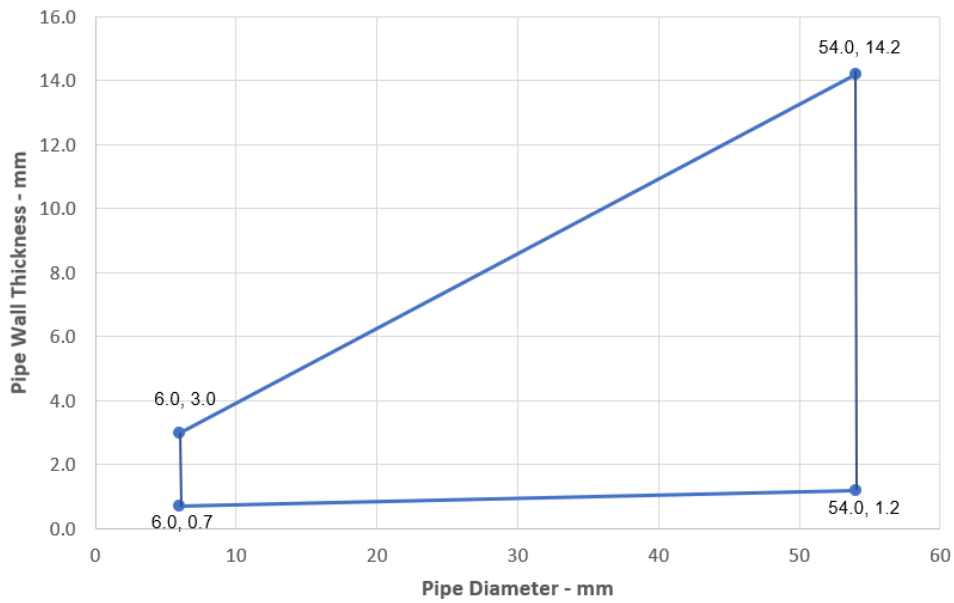

Declaration of Performance
 SikaSeal-632 Fire Putty+
 30816702
 2021.12 , ver. 1
 1549

Template for translation. Only for
 internal use



Alupex Pipes - EI 240 C/C

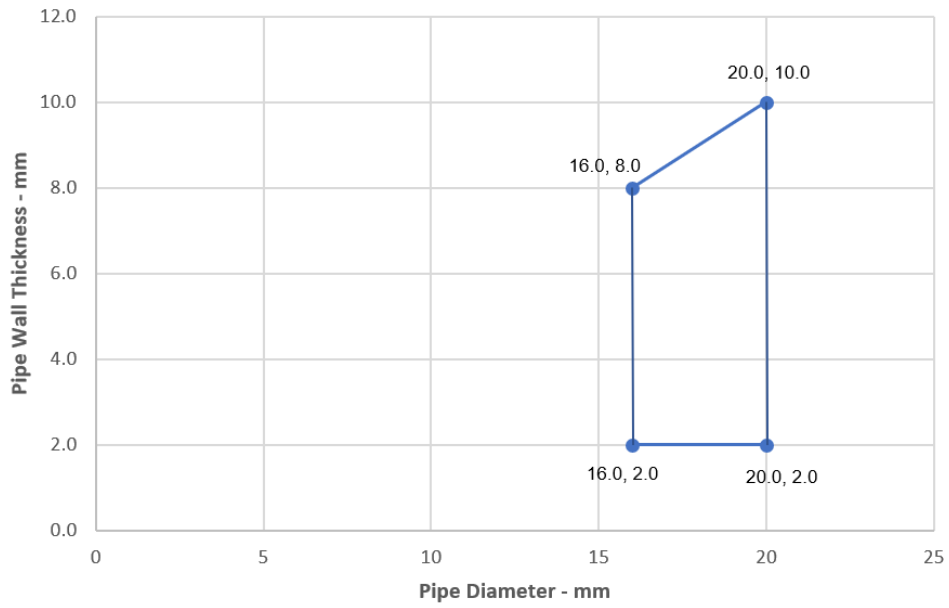

Declaration of Performance
SikaSeal-632 Fire Putty+
30816702
2021.12 , ver. 1
1549

Template for translation. Only for
internal use



A.4.6 Double sided penetration seal with metallic pipes

Penetration Seal: Metallic pipes penetrating through a rigid floor construction and fitted at any position within the aperture, sealed with a 15mm diameter cord of SikaSeal-632 Fire Putty+ on both sides of the floor. Maximum annular space 10 mm (A1) and minimum separation between penetration seals 30 mm (A2).

Construction details:

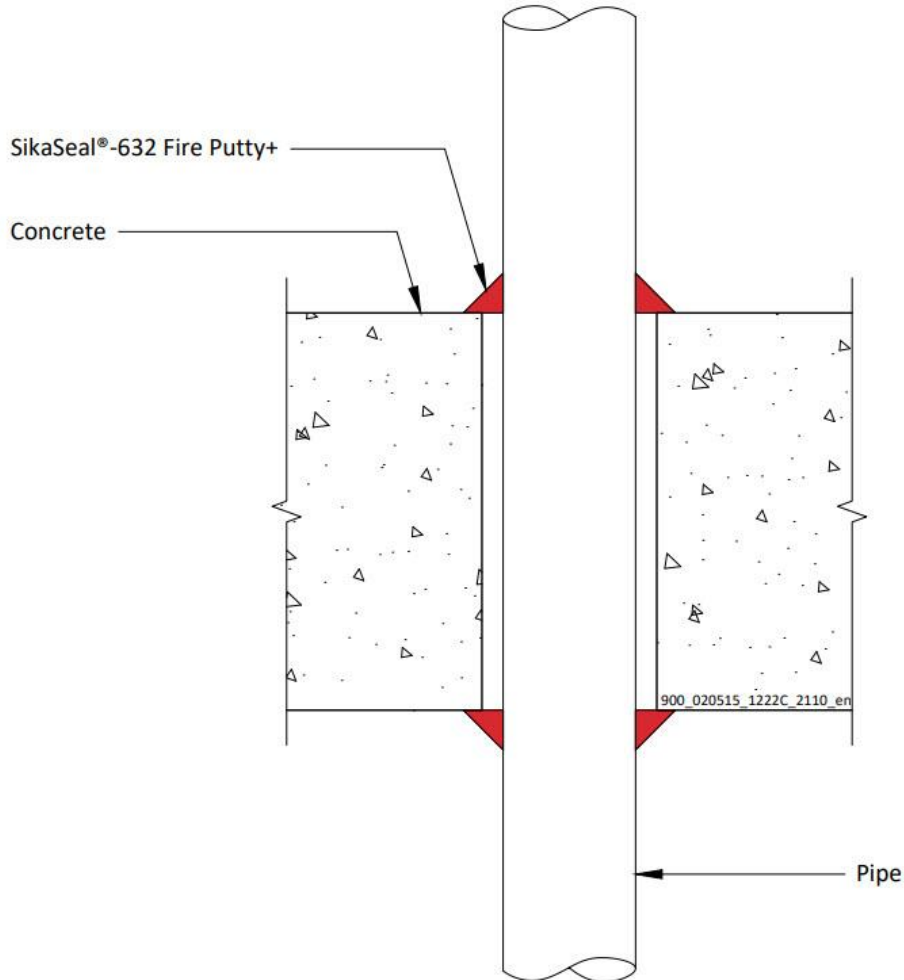

A.4.6.1

Services	Insulation	Classification
Copper or steel pipe		
Maximum 10 mm diameter/0.7-14.2 mm wall	None needed	E 240, EI 180 C/C

Declaration of Performance

SikaSeal-632 Fire Putty+
30816702
2021.12 , ver. 1
1549

Template for translation. Only for
internal use

A.4.7 Single sided penetration seal with insulated metallic pipes, Local Interrupted (LI)

Penetration Seal: Metallic pipes insulated with minimum 80 kg/m³ density mineral wool insulation, Local Interrupted (LI), penetrating through a rigid floor construction, fitted at any position within the aperture, sealed with a 15 mm diameter cord of SikaSeal-632 Fire Putty+ on the top face of the floor. Maximum annular space 10 mm (A1) and minimum separation between penetration seals 30 mm (A2).

Construction details:

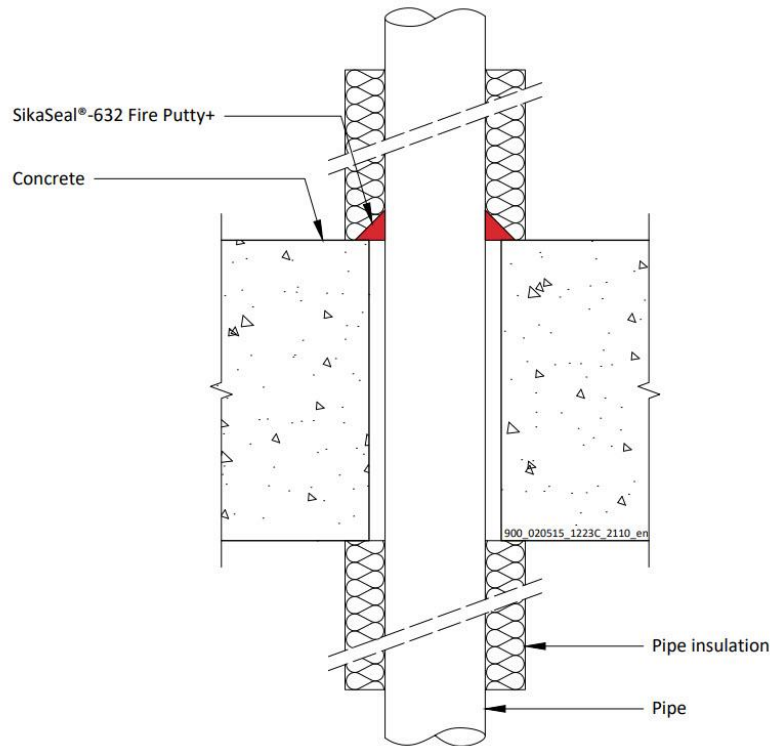

A.4.7.1 Single sided penetration seal with partially insulated metallic pipes

Services	Insulation	Classification
Mild or stainless steel pipe, with minimum 80 kg/m ³ density mineral wool insulation		
Maximum 40 mm diameter*	Minimum 20 mm thick insulation, 500 mm long butted up to each face of the floor	EI 240 C/U
41-324 mm diameter*	Minimum 30 mm thick insulation, 500 mm long butted up to each face of the floor	E 240, EI 60 C/U
ALUPEX pipe with minimum 80 kg/m ³ density mineral wool insulation		
Maximum 16 mm diameter/2.25-8.0 mm wall*	Minimum 20 mm thick insulation, 500 mm long butted up to each face of the floor	EI 240 C/C
Maximum 75 mm diameter/4.6-14.2 mm wall*	Minimum 30 mm thick insulation, 500 mm long butted up to each face of the floor	EI 240 C/C

*See below graphs for interpolation pipe sizes

Declaration of Performance
 SikaSeal-632 Fire Putty+
 30816702
 2021.12 , ver. 1
 1549

Template for translation. Only for
 internal use

Steel Pipes with 30 mm Thick Insulation - E 240, EI 60, C/U

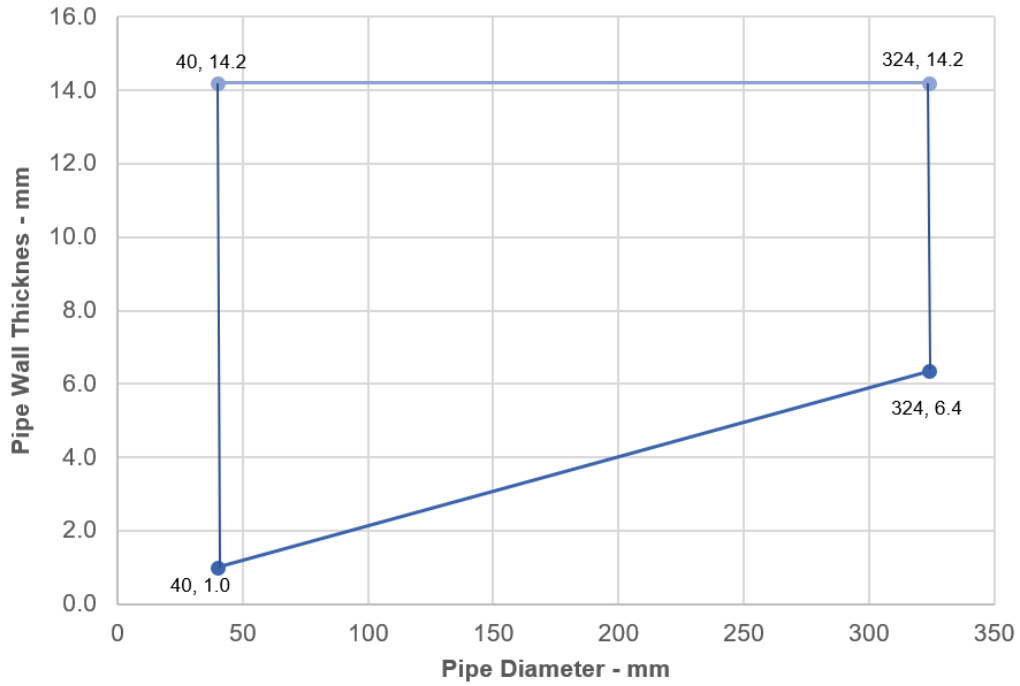

Alupex Pipes with 30 mm Thick Pipe Insulation EI 240 C/C

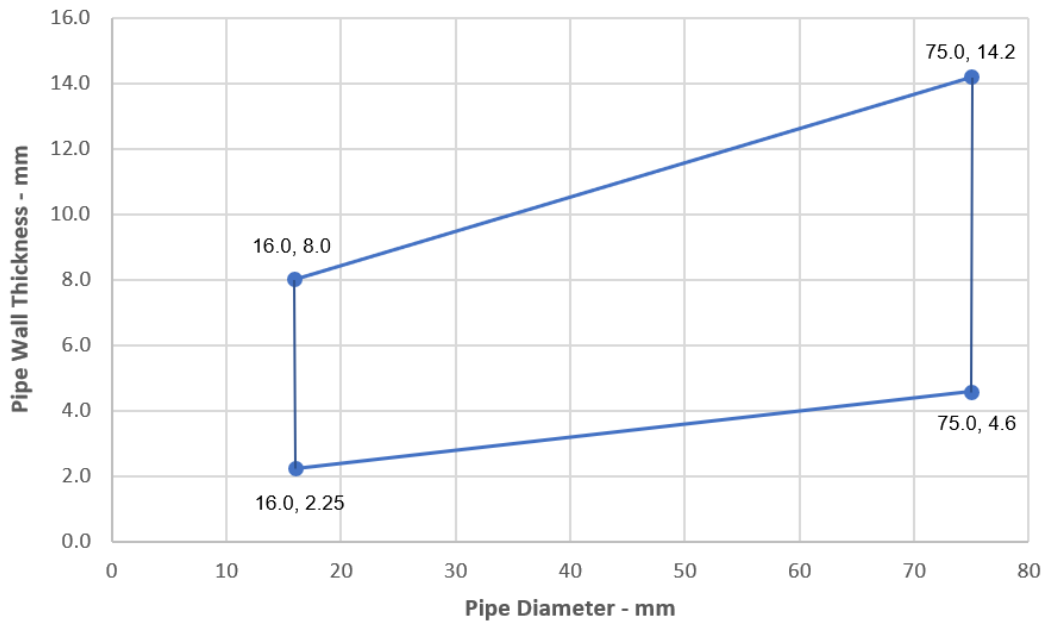

Declaration of Performance
SikaSeal-632 Fire Putty+
30816702
2021.12 , ver. 1
1549

Template for translation. Only for
internal use

A.4.8 Single sided penetration seal with insulated metallic pipes, Local Interrupted (LI)

Penetration Seal: Metallic pipes insulated with minimum 75 kg/m³ density glass or mineral wool insulation, Local Interrupted (LI), penetrating through a rigid floor construction, fitted at any position within the aperture, sealed with a 15 mm diameter cord of SikaSeal-632 Fire Putty+ on the top face of the floor. Maximum annular space 10 mm (A1) and minimum separation between penetration seals 30 mm (A2).

Construction details:

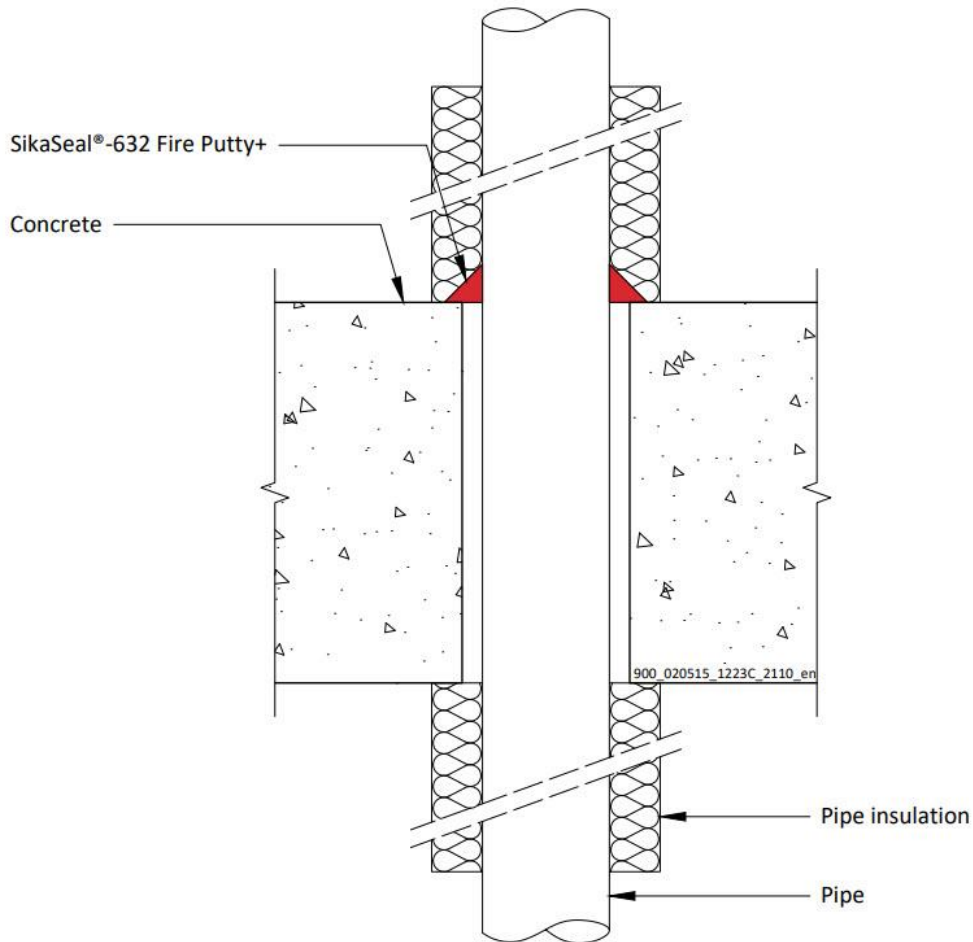

A.4.8.1

Services	Insulation	Classification
Copper or steel pipe with minimum 75 kg/m ³ density glass or mineral wool insulation		
Maximum 12 mm diameter/0.7-14.2 mm wall*	Minimum 20 mm thick insulation, 500 mm long butted up to each face of the floor	EI 240 C/C
Maximum 54 mm diameter/1.2-14.2 mm wall*		E 180, EI 120 C/C

*See below graphs for interpolation pipe sizes

Declaration of Performance

SikaSeal-632 Fire Putty+
30816702
2021.12 , ver. 1
1549

Template for translation. Only for internal use

Copper or Steel Pipes - E 180, EI 120 C/C

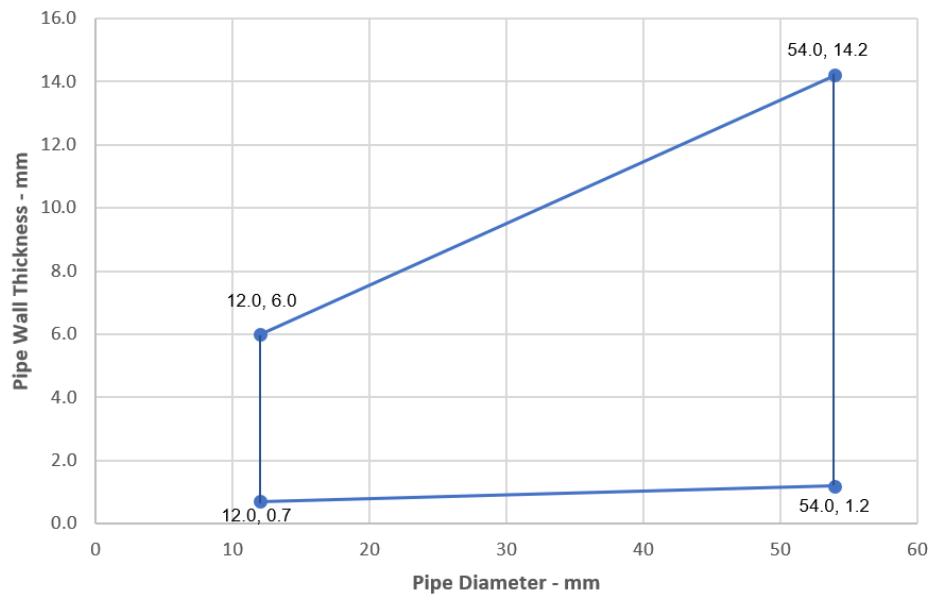

Declaration of Performance
SikaSeal-632 Fire Putty+
30816702
2021.12 , ver. 1
1549

Template for translation. Only for
internal use

A.4.9 Single sided penetration seal with insulated metallic pipes, Continuous Sustained (CS)

Penetration Seal: Metallic pipes insulated with minimum 80 kg/m³ density mineral wool insulation, Continuous Sustained (CS), penetrating through a rigid floor construction, fitted at any position within the aperture, sealed with a 15mm diameter cord of SikaSeal-632 Fire Putty+ on the top face of the floor. Maximum annular space 10 mm (A1) and minimum separation between penetration seals 30 mm (A2).

Construction details:

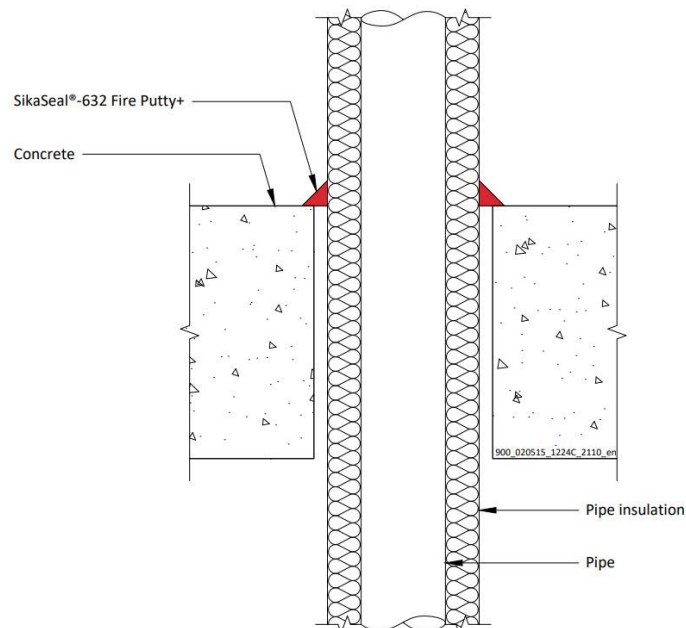

A.4.9.1

Services	Insulation	Classification
Mild or stainless steel pipe, with minimum 80 kg/m ³ density mineral wool insulation		
Maximum 40 mm diameter/1.0-14.2 mm wall	20 mm thick	EI 240 C/U
Maximum 324 mm diameter*	30-80mm thick	EI 240 C/U
Copper or steel pipe with minimum 80 kg/m ³ density mineral wool insulation		
Maximum 12 mm diameter/0.7-6.0 mm wall*	20 mm thick	EI 240 C/C
Maximum 54 mm diameter/1.2-14.2 mm wall*	30-80mm thick	EI 240 C/C
ALUPEX pipe with minimum 80 kg/m ³ density mineral wool insulation		
Maximum 16 mm diameter/2.25-8.0 mm wall*	20 mm thick	EI 240 C/C
Maximum 75 mm diameter/4.6-14.2 mm wall*	30-80mm thick	EI 240 C/C

*See below graphs for interpolation pipe sizes

Declaration of Performance

SikaSeal-632 Fire Putty+
30816702
2021.12, ver. 1
1549

Template for translation. Only for
internal use

Steel Pipes with 30-80 mm Thick Insulation - EI 240 C/U

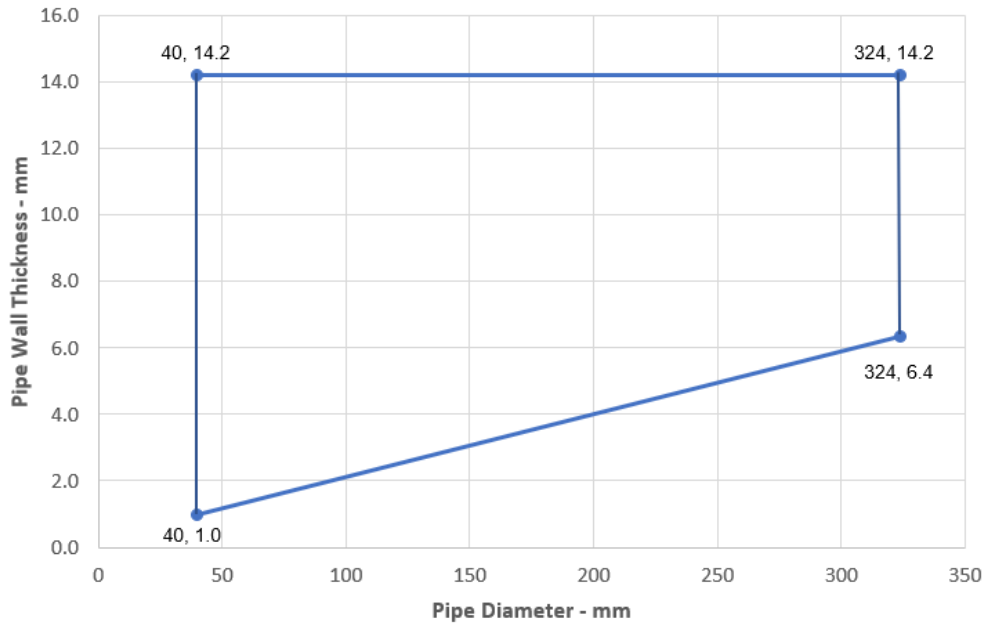

Copper or Steel Pipes with 30-80 mm Thick Insulation EI 240 C/C

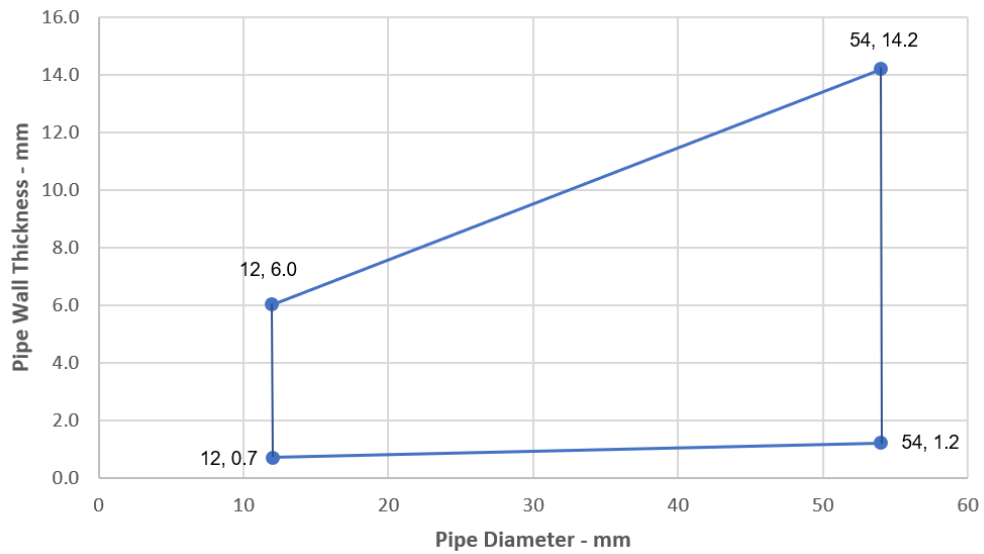

**Alupex Pipes with 30-80 mm Thick Insulation
EI 240 C/C**

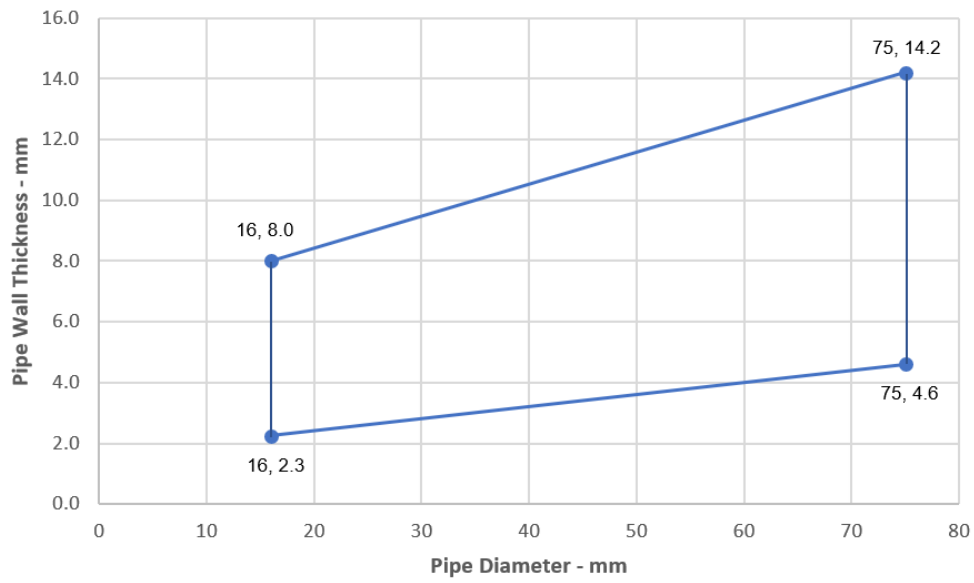

Declaration of Performance
SikaSeal-632 Fire Putty+
30816702
2021.12 , ver. 1
1549

Template for translation. Only for
internal use



A.4.10 Single sided penetration seal with insulated metallic pipes, Continuous Sustained (CS)

Penetration Seal: Metallic pipes insulated with minimum 75 kg/m³ density glass wool insulation, Continuous Sustained (CS), penetrating through a rigid floor construction, fitted at any position within the aperture, sealed with a 15mm diameter cord of SikaSeal-632 Fire Putty+ on the top face of the floor. Maximum annular space 10 mm (A1) and minimum separation between penetration seals 30 mm (A2).

Construction details:

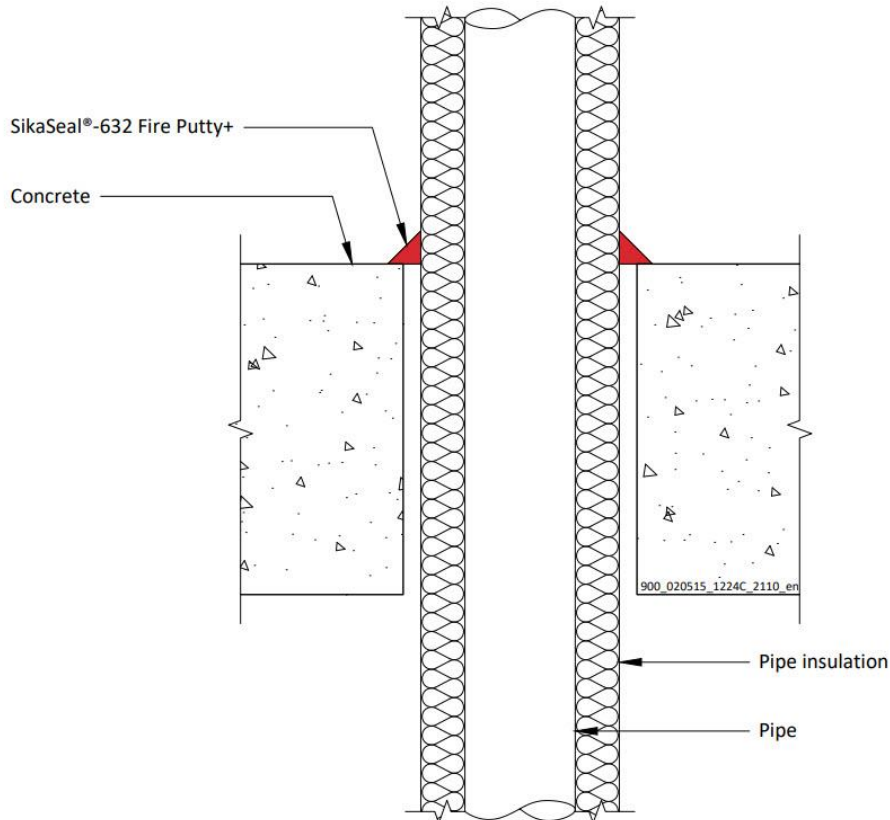

A.4.10.1

Services	Insulation	Classification
Copper or steel pipe with minimum 75 kg/m ³ density glass wool insulation		
Maximum 12 mm diameter/0.7-6.0 mm wall*	20 mm thick	EI 240, EI 90 C/C
Maximum 54 mm diameter/1.2-14.2 mm wall*	20-40mm thick	EI 90 C/C
ALUPEX pipe with minimum 75 kg/m ³ density glass wool insulation		
Maximum 16 mm diameter/2.25-8.0 mm wall*	20 mm thick	EI 120 C/C
Maximum 75 mm diameter/4.6-14.2 mm wall*	20-50mm thick	EI 120 C/C

*See below graphs for interpolation pipe sizes

Declaration of Performance
 SikaSeal-632 Fire Putty+
 30816702
 2021.12 , ver. 1
 1549

Template for translation. Only for
 internal use

Copper or Steel Pipes - EI 90 C/C

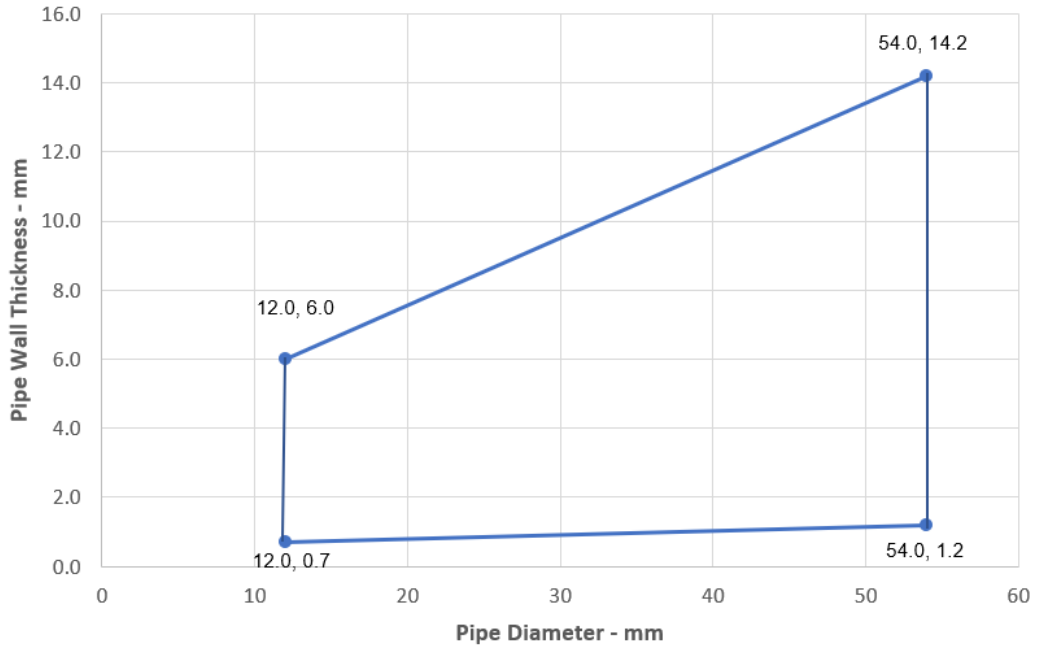

Alupex Pipes - EI 120 C/C

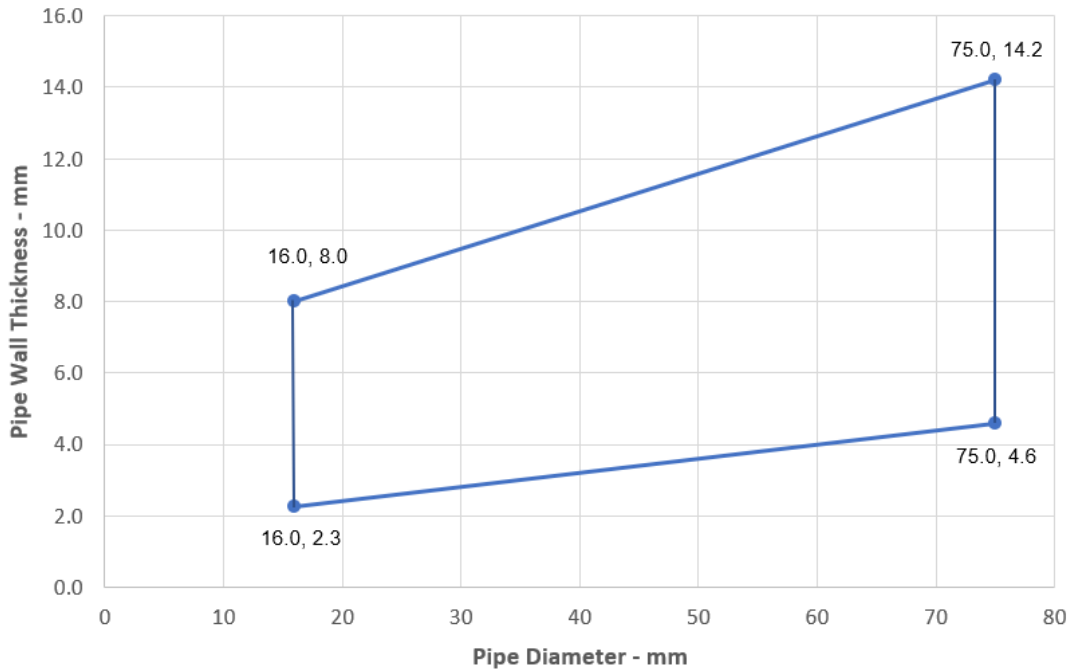

ANNEX B – AIR PERMEABILITY – SIKASEAL-632 FIRE PUTTY+

Product tested	SikaSeal-632 Fire Putty+ Cord around 48mm electrical cable in 58mm hole		
	Summary of testing procedure		Result
	Pressure (Pa)	Leakage (m ³ /h)	Leakage (m ³ /m ² /h)
Results under negative chamber pressure	25	0.32	N/A
	50	0.60	N/A
	100	1.00	N/A
	200	1.63	N/A
	300	2.26	N/A
	600	2.64	N/A
	1000	3.25	N/A
Results under positive chamber pressure	25	0.24	N/A
	50	0.26	N/A
	100	0.36	N/A
	200	0.56	N/A
	300	1.11	N/A
	600	1.88	N/A
	1000	2.49	N/A

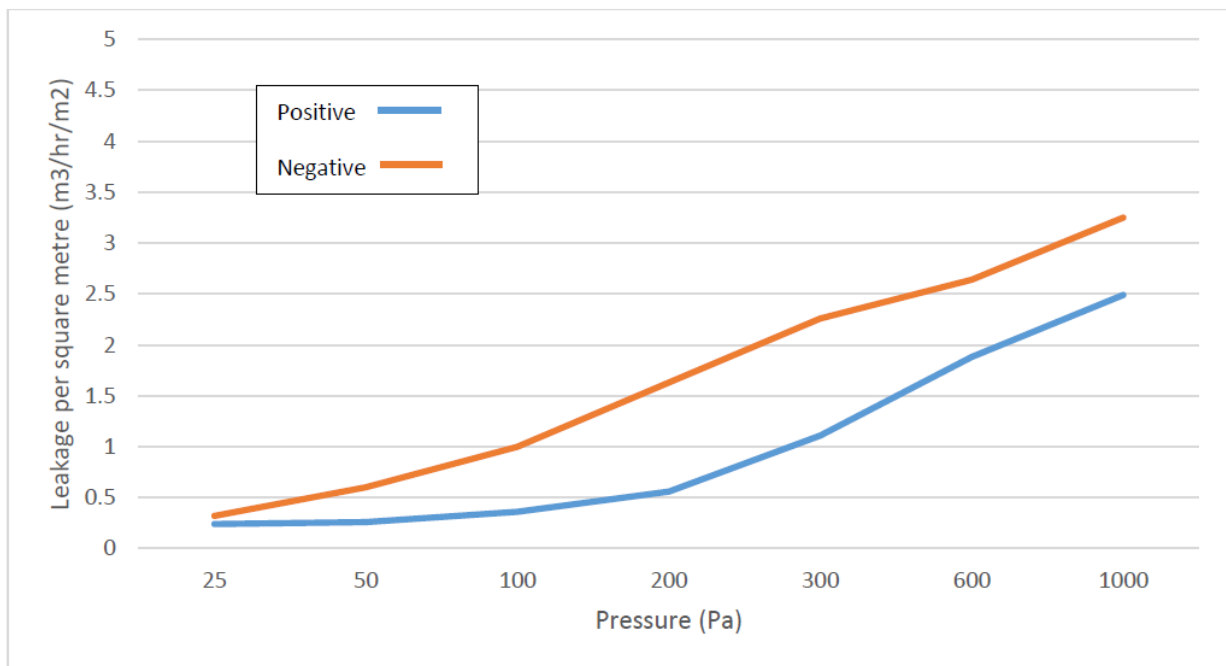

**8 APPROPRIATE TECHNICAL DOCUMENTATION AND/OR -
SPECIFIC TECHNICAL DOCUMENTATION**

The performance of the product identified above is in conformity with the set of declared performance/s. This declaration of performance is issued, in accordance with Regulation (EU) No 305/2011, under the sole responsibility of the manufacturer identified above.

Signed for and on behalf of the manufacturer by:

Name: Anders Beier
Function: General Manager
At Farum on 3 May 2022

Name: Stan Petersen
Function: Head Distribution
At Farum on 3 May 2022



.....

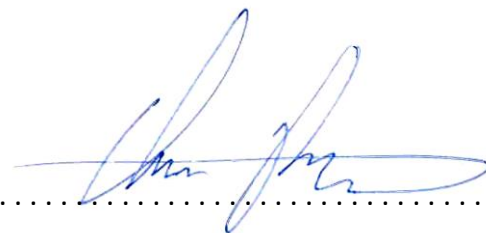

.....

End of information as required by Regulation (EU) No 305/2011

FULL CE MARK

 21
Sika Services AG, Zurich, Switzerland
30816702
Resistance to fire - Annex A
Air permeability – Annex B
Durability Z ₂
Airborne sound insulation - Rw (C;C _{tr})= 67 (-2;-7) dB

Declaration of Performance
SikaSeal-632 Fire Putty+
30816702
2021.12 , ver. 1
1549

38/73

Template for translation. Only for
internal use

BUILDING TRUST



ANNEX A – RESISTANCE TO FIRE CLASSIFICATION – SIKASEAL-632 FIRE PUTTY+

A.1 Flexible wall constructions with wall thickness of minimum 100 mm

A.1.1 Pipe and cable penetration seals with 4 mm thick SikaSeal-632 Fire Putty+ in socket box

Penetration Seal: Socket boxes with 15 mm long SikaSeal-632 Fire Putty+ wrapped around the pipe protrusion from the socket box. Min. 30 mm between cable penetrations.

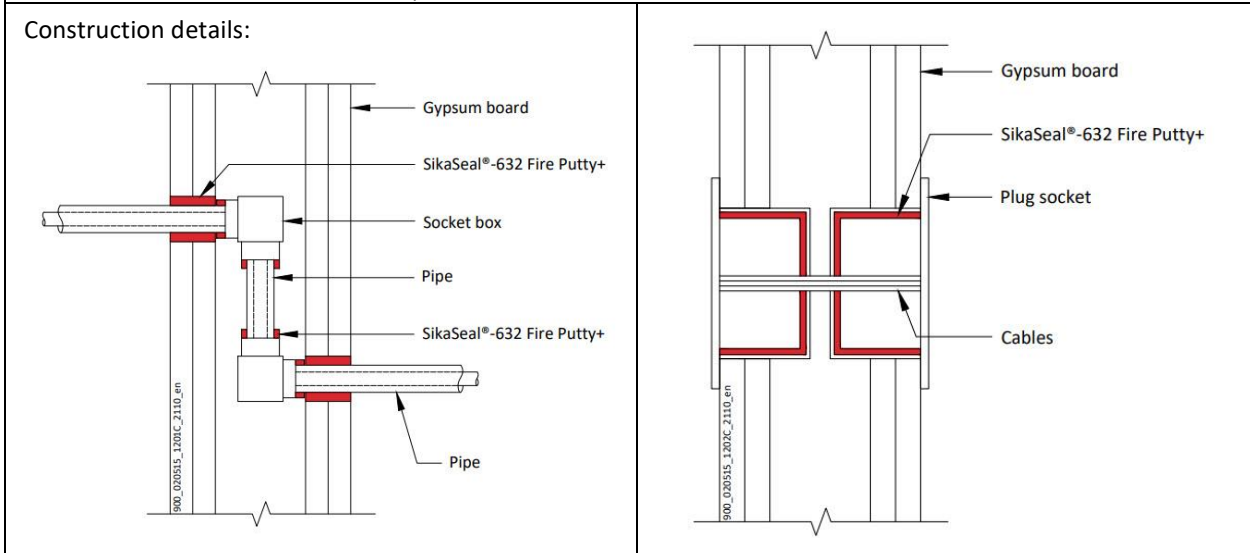

A.1.1.1 Double side penetration seal with pipes in socket boxes

Services	Socket box	SikaSeal-632 Fire Putty+ - mm	Aperture mm	Classification
Høiax 25mm PEX pipe in pipe hose	Single or double Høiax Push Wallbox 15mm*	174 x 64 x 4 mm pad around pipe / 50 Ø x 25 mm at back of the box	63 Ø	EI 90
Cables up to 14 mm diameter	UK standard double socket box, maximum 130mm wide x 70mm high x 47mm deep, each with up to 22mm hole cut to accept the cables	Interior of box fully lined with pad	Maximum 135 wide x 75 high	EI 60

*Fixed directly to studs or with steel plate between studs.

A.1.2 Cable penetration seals with 4 mm thick SikaSeal-632 Fire Putty+ in socket box

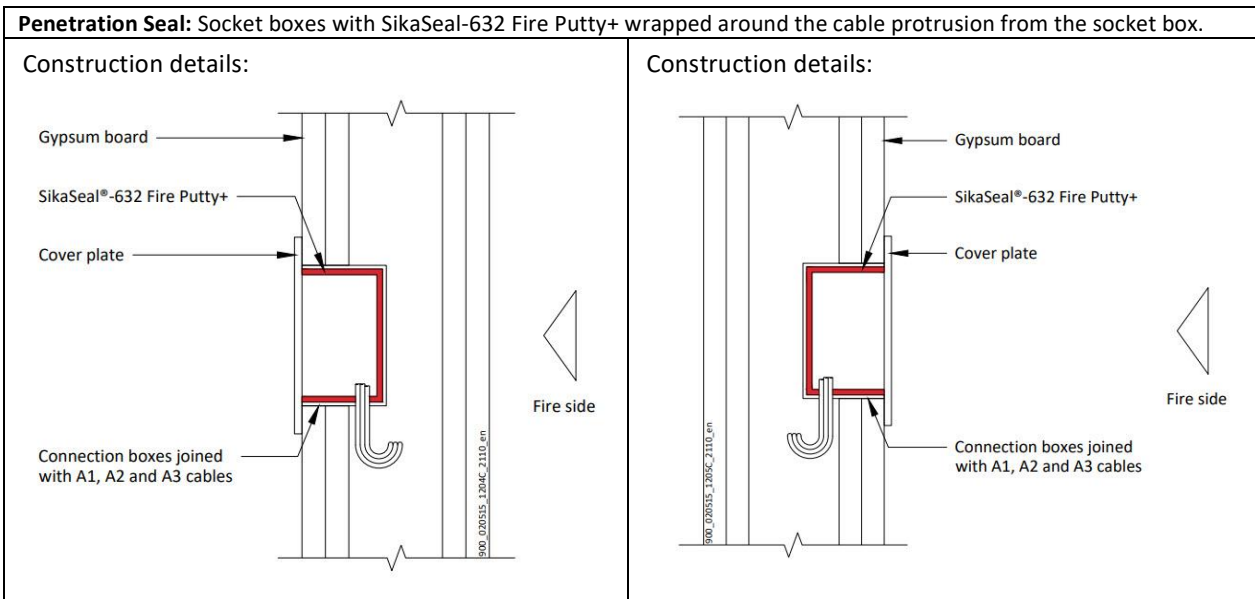

A.1.2.1 Single side penetration seal with cables in socket boxes

Services	Socket box	SikaSeal-632 Fire Putty+	Position	Aperture mm	Classification
Cables up to 14 mm diameter	Schneider Electric Ref. IMT 36026 connection box, 72mm wide x 90mm high x 50mm deep	Fitted lining the back of the back box	Side by side – 1 fitted to each face, or separated	73 wide x 91 High x 51 deep	E 60, EI 45
Cables up to 14 mm diameter	Elko 4189 1223720 connection box, 72mm wide x 90mm high x 58mm deep	Interior of box fully lined with pad	Adjacent – 1 fitted to each face, or separated	92 wide x 112 High	EI 90
Cables up to 14 mm diameter	ELKO 5421 123740 connection box, 73mm wide x 73mm high x 55mm deep	Interior of box fully lined with pad	Side by side – 1 fitted to each face, or separated	74 wide x 74 High	EI 90

A.1.3 Double sided penetration seal with cables

Penetration Seal: Cables (single or bundled up to 50 mm \varnothing) penetrating through a flexible or rigid wall construction and fitted at any position within the aperture, sealed with a 15mm diameter cord of SikaSeal-632 Fire Putty+ on both sides of the wall. Maximum annular space 10 mm (A1) and minimum separation between penetration seals 30 mm (A2).

Construction details:

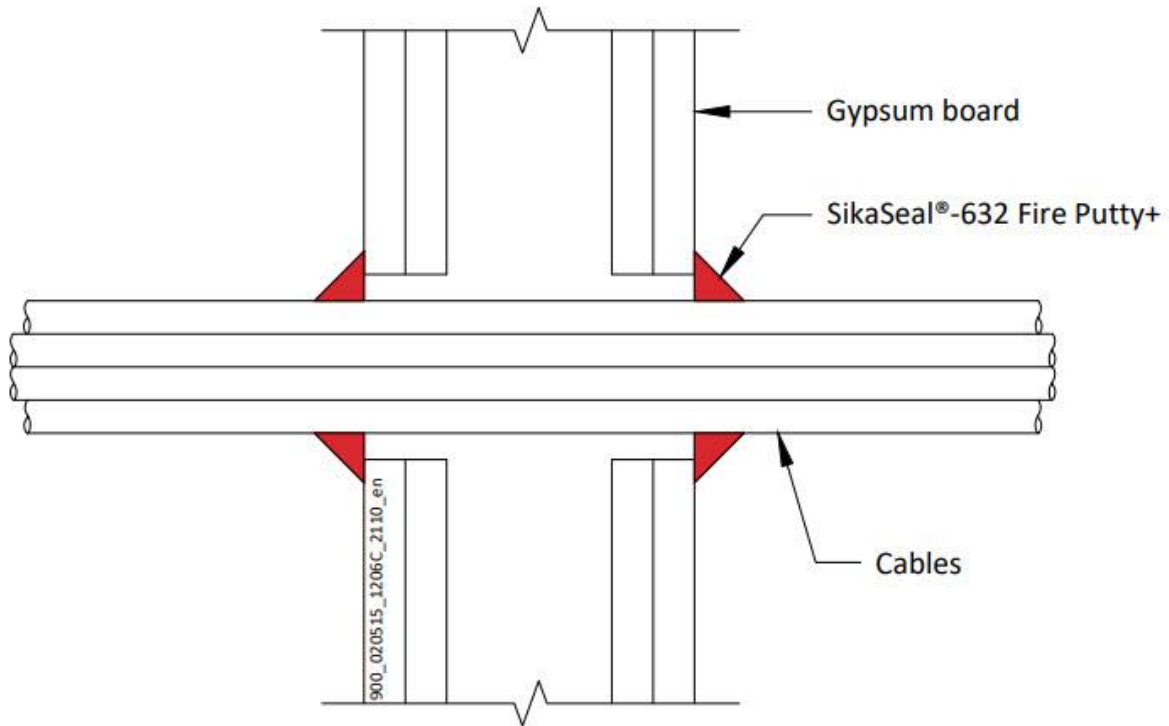

A.1.3.1

Services	Classification
Blank seal with a 15 mm deep cord of SikaSeal-632 Fire Putty+ on both sides of the wall	EI 120
Cables up to 21 mm diameter, single or in a bundle up to 50 mm diameter*	EI 120
Cables up to 80 mm diameter, single or in a bundle up to 50 mm diameter*	EI 60

* Cable specification from EN 1366-3 standard cable configuration

A.1.4 Double sided penetration seal with metallic pipes

Penetration Seal: Metallic pipes penetrating through a flexible or rigid wall construction and fitted at any position within the aperture, sealed with a 15mm diameter cord of SikaSeal-632 Fire Putty+ on both sides of the wall. Maximum annular space 10 mm (A1) and minimum separation between penetration seals 30 mm (A2).

Construction details:

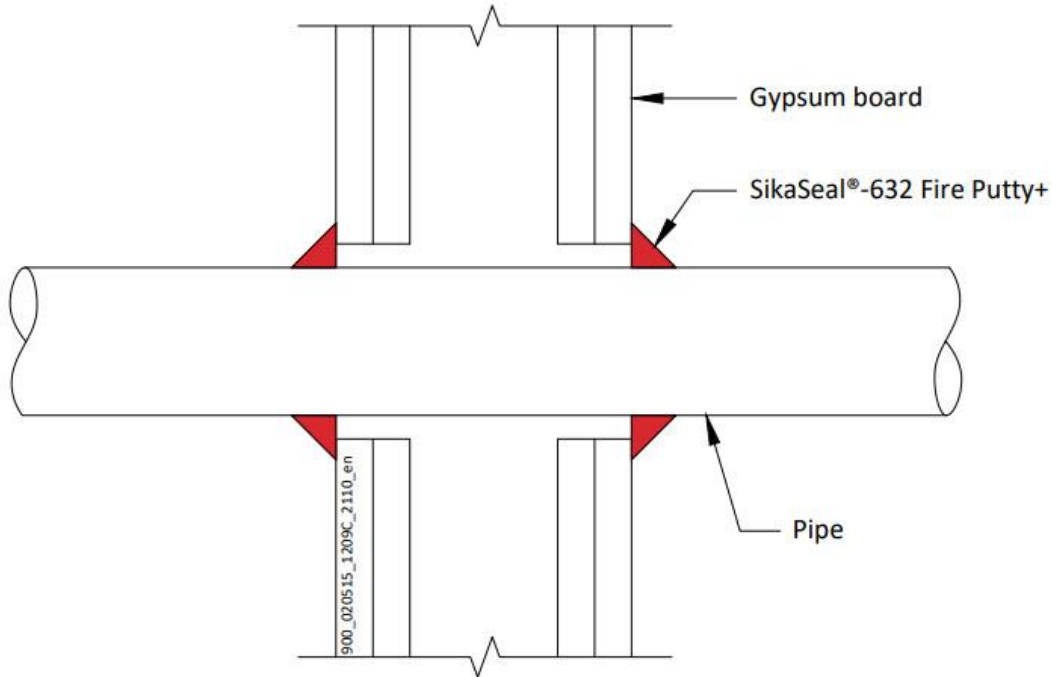

A.1.4.1

Services	Insulation	Classification
Mild or stainless steel pipe		
Maximum 22 mm diameter*	None needed	EI 120 C/U
23-30 mm diameter*	None needed	E 120, EI 45 C/U
ALUPEX pipe		
16 mm diameter*	None needed	EI 120 C/C
17-20 mm diameter*	None needed	E 120, EI 90 C/C
Copper or steel pipe		
6 mm diameter*	None needed	EI 120 C/C
7-12 mm diameter*	None needed	E 120, EI 60 C/C

*See below graphs for interpolation pipe sizes

Declaration of Performance
 SikaSeal-632 Fire Putty+
 30816702
 2021.12 , ver. 1
 1549

Template for translation. Only for
 internal use

Mild or Stainless Steel Pipes - EI 120 C/C

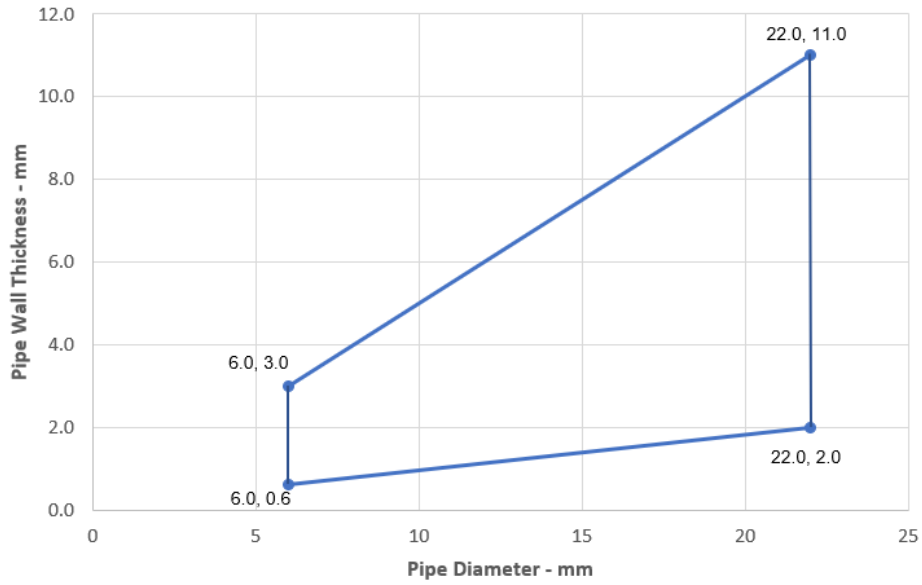

Steel Pipes - E 120, EI 45 C/U

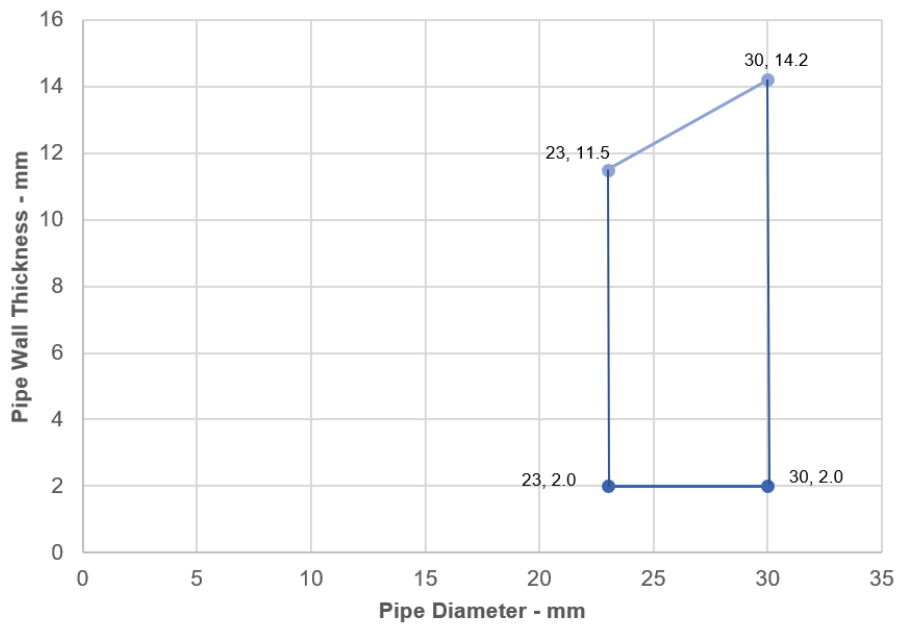

Declaration of Performance
 SikaSeal-632 Fire Putty+
 30816702
 2021.12 , ver. 1
 1549

Template for translation. Only for
 internal use

ALUPEX Pipes - E 120, EI 90 C/C

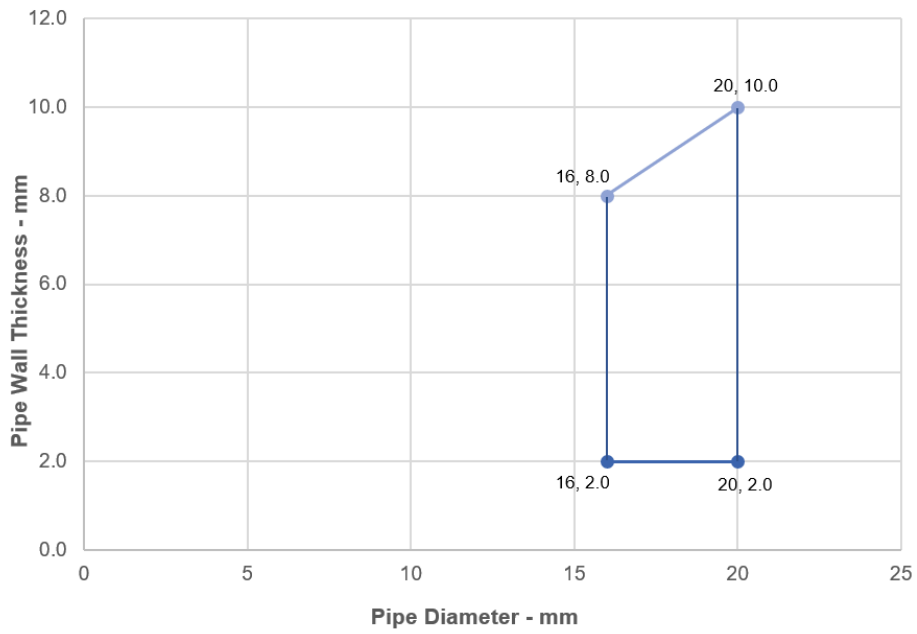

Copper Pipes- E120, EI 60 C/C

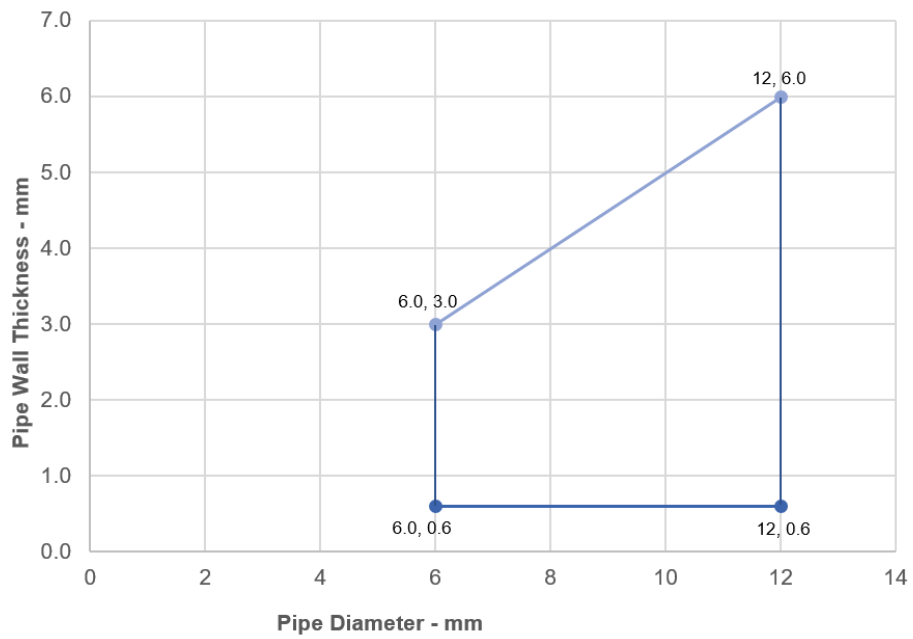

Declaration of Performance
SikaSeal-632 Fire Putty+
30816702
2021.12 , ver. 1
1549

Template for translation. Only for
internal use

A.1.5 Double sided penetration seal with insulated metallic pipes, Local Interrupted (LI)

Penetration Seal: Metallic pipes insulated with minimum 80 kg/m³ density mineral wool insulation, Local Interrupted (LI), penetrating through a flexible or rigid wall construction, fitted at any position within the aperture, sealed with a 15mm diameter cord of SikaSeal-632 Fire Putty+ on both sides of the wall. Maximum annular space 10 mm (A1) and minimum separation between penetration seals 30 mm (A2).

Construction details:

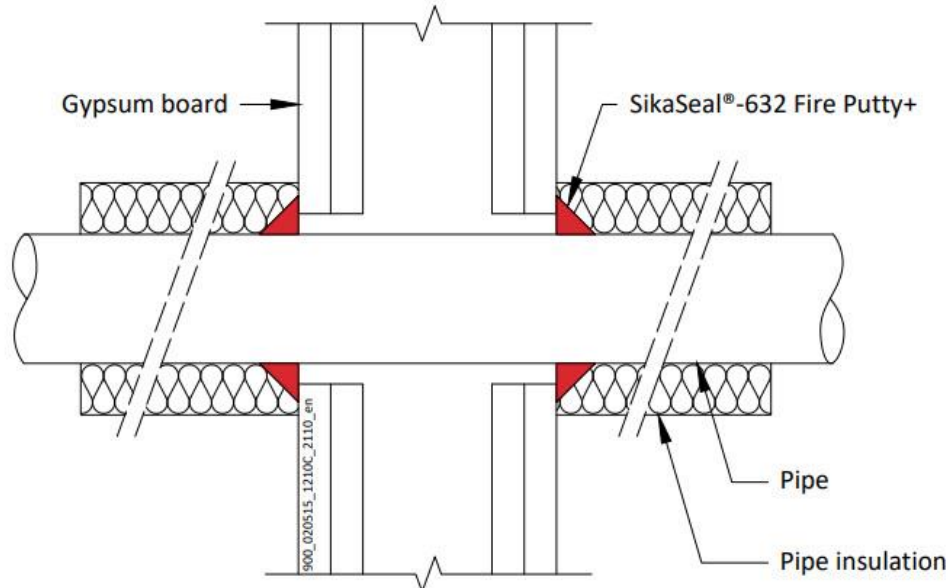

A.1.5.1

Services	Insulation	Classification
Mild or stainless steel pipe, with minimum 80 kg/m ³ density mineral wool insulation		
Maximum 40 mm diameter*	Minimum 20 mm thick insulation, 500 mm long butted up to the wall on both faces	EI 120 C/U
40-324 mm diameter*	Minimum 30 mm thick insulation, 500 mm long butted up to the wall on both faces	EI 120 C/U
Copper or steel pipe with minimum 80 kg/m ³ density mineral wool insulation		
Maximum 54 mm diameter/1.2-14.2 mm wall	Minimum 20 mm thick insulation, 500 mm long butted up to the wall on both faces	E 90, EI 60 C/C
ALUPEX pipe with minimum 80 kg/m ³ density mineral wool insulation		
Maximum 16 mm diameter*	Minimum 20 mm thick insulation, 500 mm long butted up to the wall on both faces	EI 90 C/C
Maximum 75 mm diameter*	Minimum 30 mm thick insulation, 500 mm long butted up to the wall on both faces	EI 90 C/C

*See below graphs for interpolation pipe sizes

Declaration of Performance

SikaSeal-632 Fire Putty+
30816702
2021.12, ver. 1
1549

Template for translation. Only for internal use

Steel Pipes with 30 mm Thick Insulation - EI 120, C/U

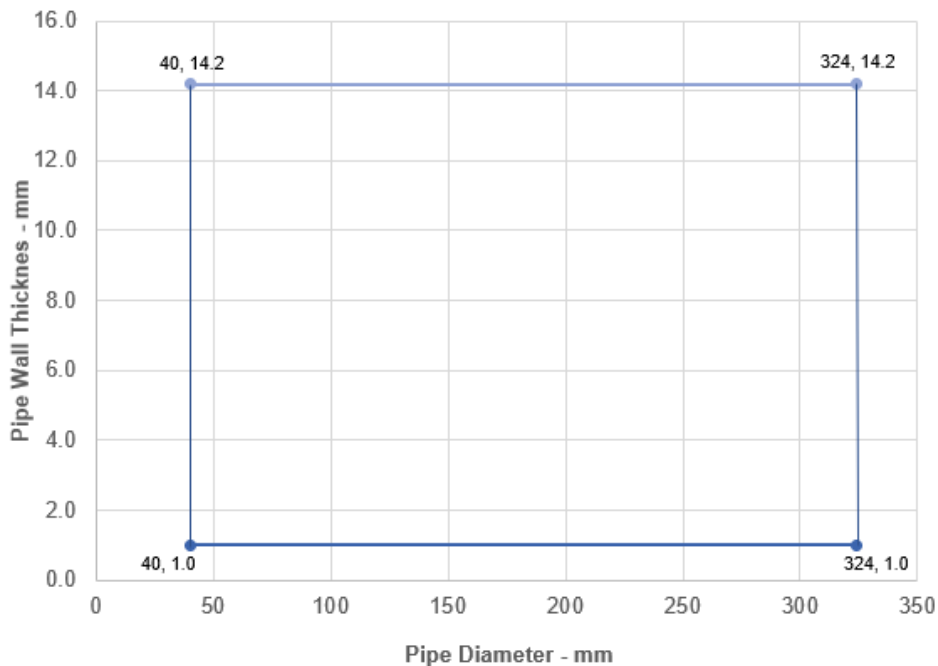

ALUPEX Pipes with 30 mm Thick Insulation - EI 90 C/C

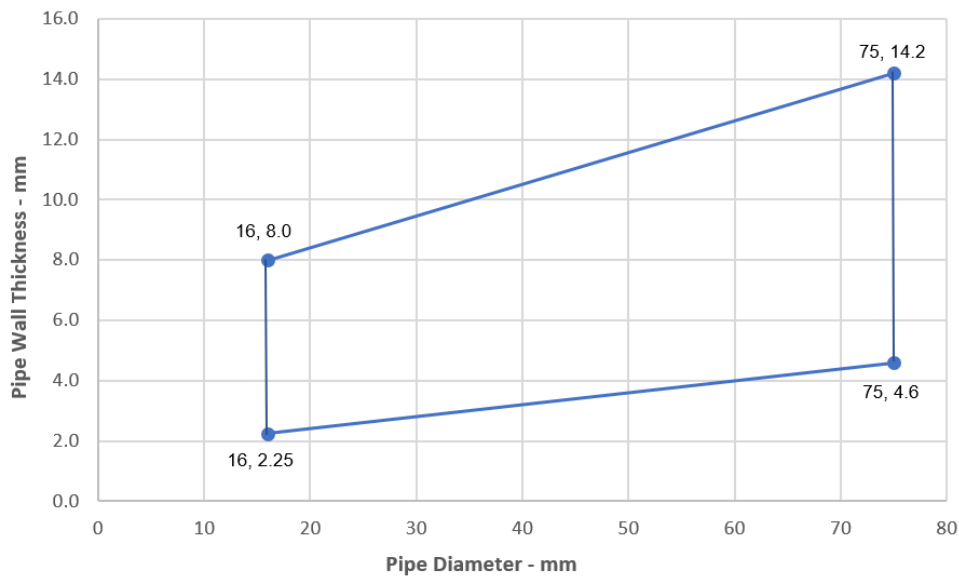

A.1.6 Double sided penetration seal with insulated metallic pipes, Continuous Sustained (CS)

Penetration Seal: Metallic pipes insulated with minimum 80 kg/m³ density mineral wool insulation, Continuous Sustained (CS), penetrating through a flexible or rigid wall construction, fitted at any position within the aperture, sealed with a 15mm diameter cord of SikaSeal-632 Fire Putty+ on both sides of the wall. Maximum annular space 10 mm (A1) and minimum separation between penetration seals 30 mm (A2).

Construction details:

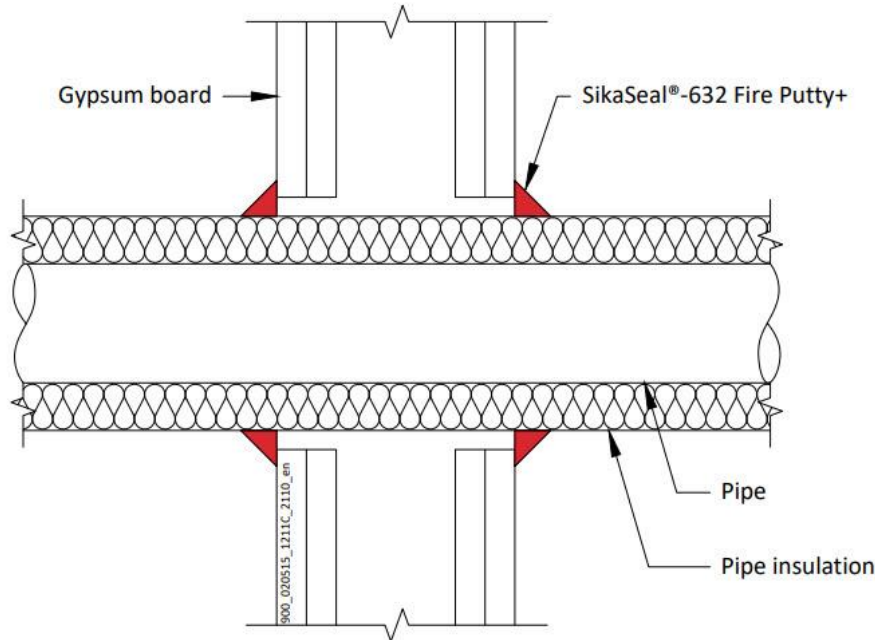

A.1.6.1

Services	Insulation	Classification
Mild or stainless steel pipe, with minimum 80 kg/m ³ density mineral wool insulation		
Maximum 40 mm diameter*	20 mm thick	EI 120 C/U
40-324 mm diameter*	30-80 mm thick	E 90, EI 60 C/U
Copper or steel pipe with minimum 80 kg/m ³ density mineral wool insulation		
Maximum 12 mm diameter/0.7-6.0 mm wall*	20 mm thick	E90, EI 60 C/C
Maximum 54 mm diameter/1.2-14.2 mm wall,	30-80 mm thick	E 90, EI 60 C/C
ALUPEX pipe with minimum 80 kg/m ³ density mineral wool insulation		
Maximum 16 mm diameter*	20 mm thick	EI 90 C/C
Maximum 75 mm diameter*	30-80 mm thick	EI 90 C/C

*See below graphs for interpolation pipe sizes

Declaration of Performance

SikaSeal-632 Fire Putty+
30816702
2021.12, ver. 1
1549

Template for translation. Only for
internal use

Steel Pipes with 30-80 mm Thick Insulation- E 90, EI 60, C/U

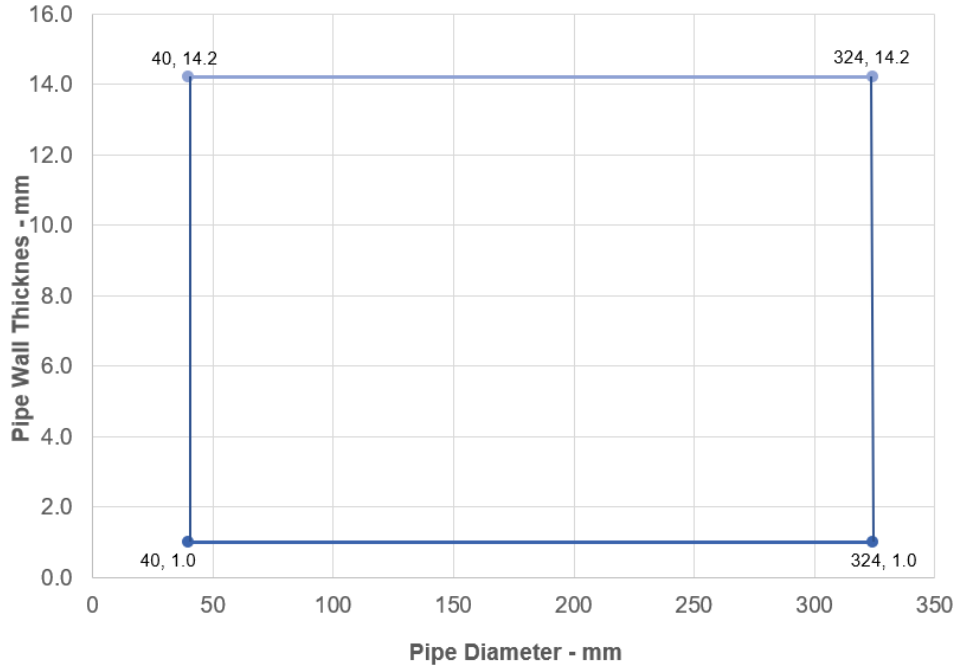

**Copper or Steel Pipes with 30-80 mm Thick Insulation
E 90, EI 60, C/C**

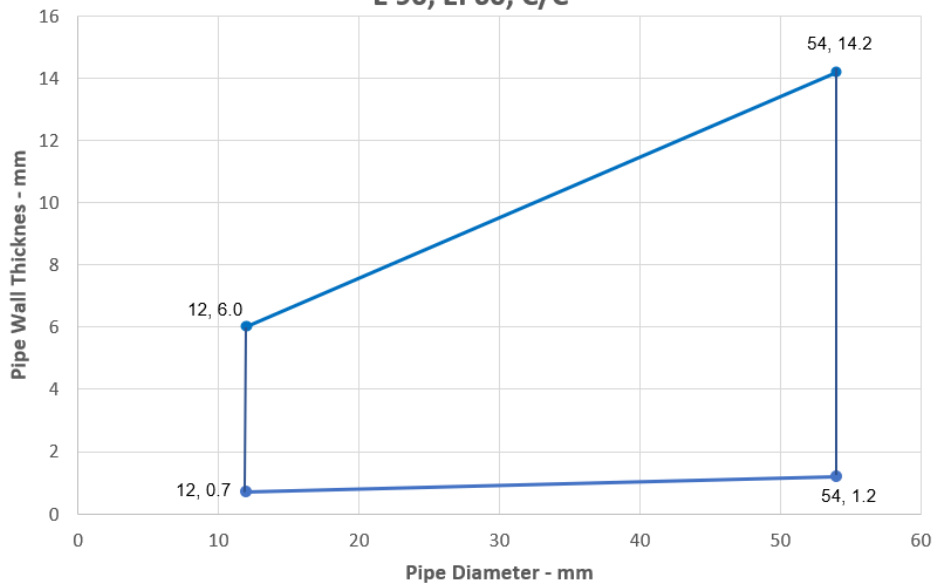

ALUPEX Pipes with 30-80 mm Thick Insulation - EI 90 C/C

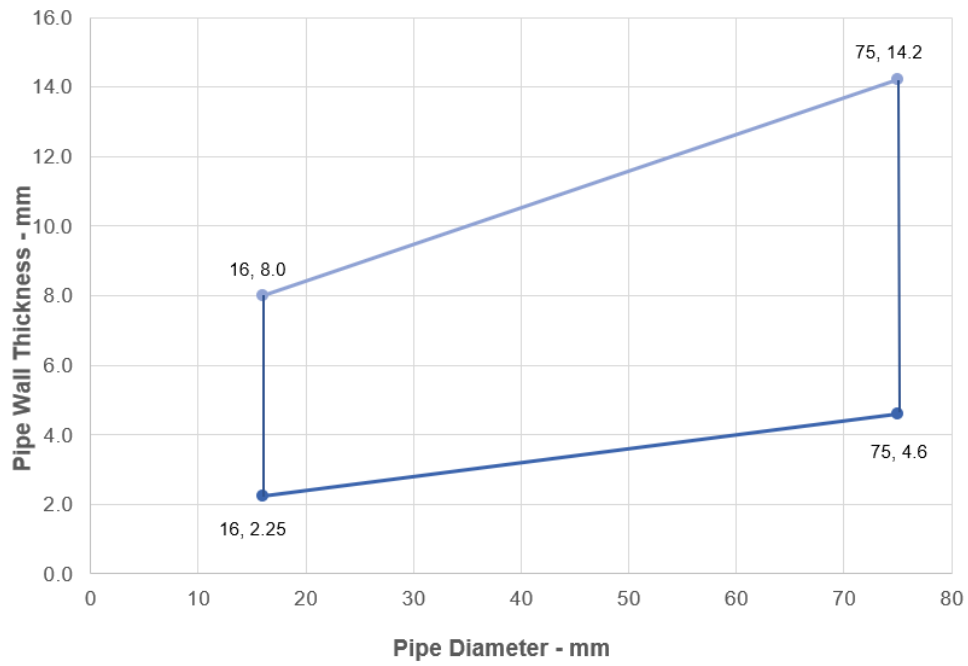

Declaration of Performance
SikaSeal-632 Fire Putty+
30816702
2021.12 , ver. 1
1549

Template for translation. Only for
internal use

A.2 Flexible wall constructions with wall thickness of minimum 120 mm

A.2.1 Cable penetration seals with 4 mm thick SikaSeal-632 Fire Putty+ in socket box

Penetration Seal: Socket boxes with SikaSeal-632 Fire Putty+ wrapped around the cable protrusion from the socket box.

Construction details:

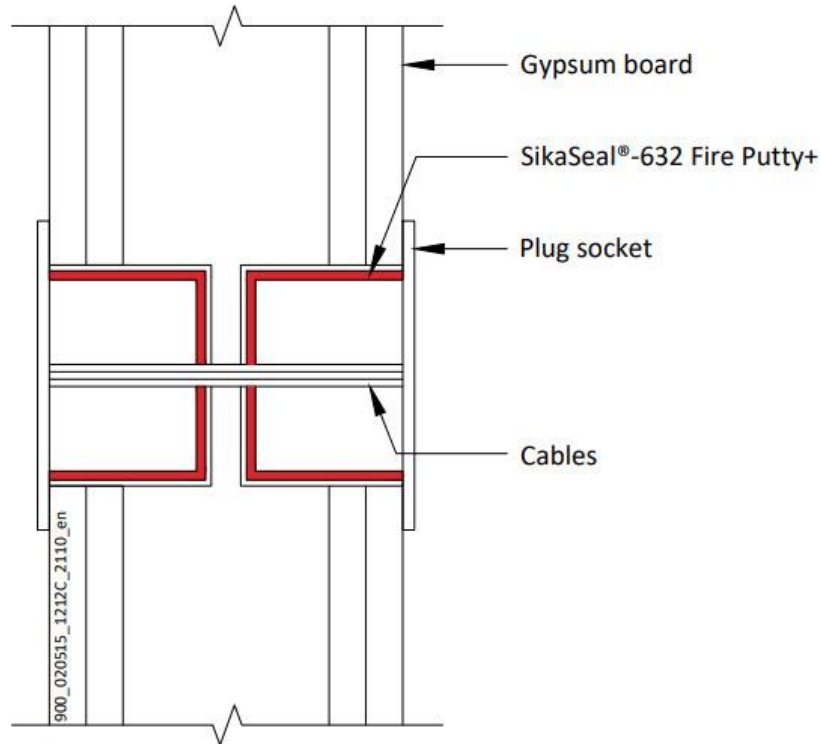

A.2.1.1 Double side penetration seal with cables in socket boxes

Services	Socket box	SikaSeal-632 Fire Putty+	Position	Aperture mm	Classification
Cables up to 14 mm diameter	UK standard double socket box, maximum 130mm wide x 70mm high x 48mm deep, each with a 25mm wide x 14mm high knock out section centrally located at the bottom back angle of the box to accept the cables	Interior of box fully lined with pad	Back to back – 1 fitted to each face, or separated	Maximum 135 wide x 72 High	EI 120
2.5 mm twin and earth cables					

A.2.2 Double sided penetration seal with metallic pipes

Penetration Seal: Metallic pipes penetrating through a flexible or rigid wall construction and fitted at any position within the aperture, sealed with a 15mm diameter cord of SikaSeal-632 Fire Putty+ on both sides of the wall. Maximum annular space 10 mm (A1) and minimum separation between penetration seals 30 mm (A2).

Construction details:

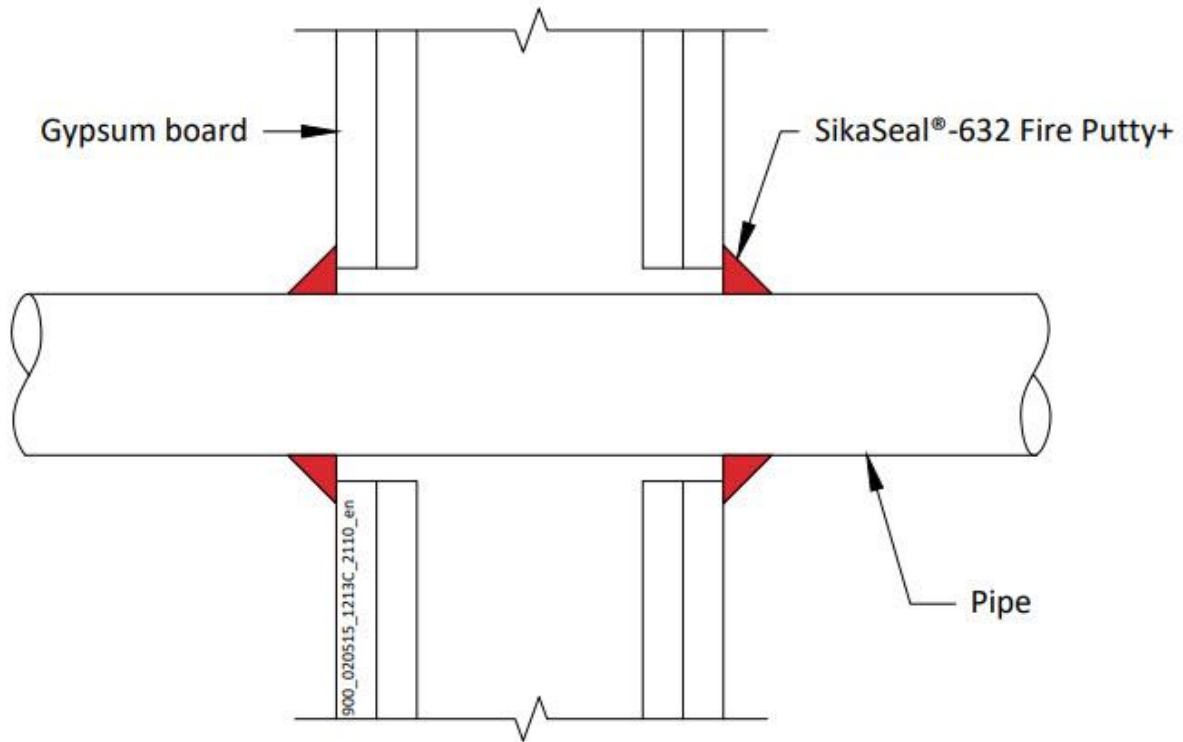

A.2.2.1

Services	Insulation	Classification
Mild or stainless steel pipe		
Maximum 324 mm diameter/6.35-14.2 mm wall	None needed	E 90, EI 20 C/U
ALUPEX pipe		
Maximum 75 mm diameter/4.6-14.2 mm wall	None needed	EI 90 C/C
Copper or steel pipe		
Maximum 54 mm diameter/1.2-14.2 mm wall	None needed	E 90, EI 15 C/C

Declaration of Performance

SikaSeal-632 Fire Putty+
30816702
2021.12 , ver. 1
1549

Template for translation. Only for
internal use

A.3 Rigid wall constructions with wall thickness of minimum 150 mm

A.3.1 Double sided penetration seal with insulated metallic pipes, Continuous Sustained (CS)

Penetration Seal: Metallic pipes insulated with minimum 80 kg/m³ density mineral wool insulation, Continuous Sustained (CS), penetrating through a rigid wall construction, fitted at any position within the aperture, sealed with a 15mm diameter cord of SikaSeal-632 Fire Putty+ on both sides of the wall. Maximum annular space 10 mm (A1) and minimum separation between penetration seals 30 mm (A2).

Construction details:

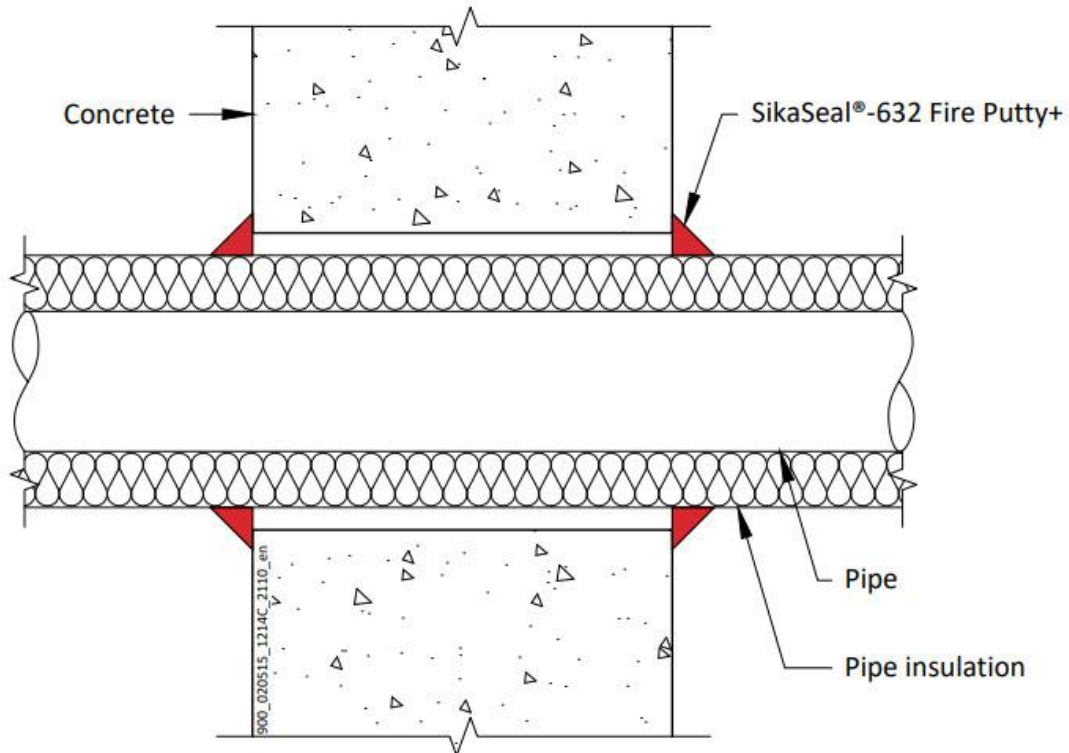

A.3.1.1

Services	Insulation	Classification
Mild or stainless steel pipe, with minimum 80 kg/m ³ density mineral wool insulation		
Maximum 40 mm diameter*	20 mm thick	EI 120 C/U
Maximum 324 mm diameter*	30-80 mm thick	E 240, EI 180 C/U
Copper or steel pipe with minimum 80 kg/m ³ density mineral wool insulation		
Maximum 54 mm diameter/1.2-14.2 mm wall	20 mm thick	E 240, EI 120 C/C
ALUPEX pipe with minimum 80 kg/m ³ density mineral wool insulation		
Maximum 16 mm diameter*	20 mm thick	EI 240 C/C
Maximum 75 mm diameter*	30 mm thick	EI 240 C/C

*See below graphs for interpolation pipe sizes

Declaration of Performance

SikaSeal-632 Fire Putty+
30816702
2021.12, ver. 1
1549

Template for translation. Only for internal use

**Mild or Stainless Pipes with 30-80 mm Thick Insulation
E 240, EI 180 C/U**

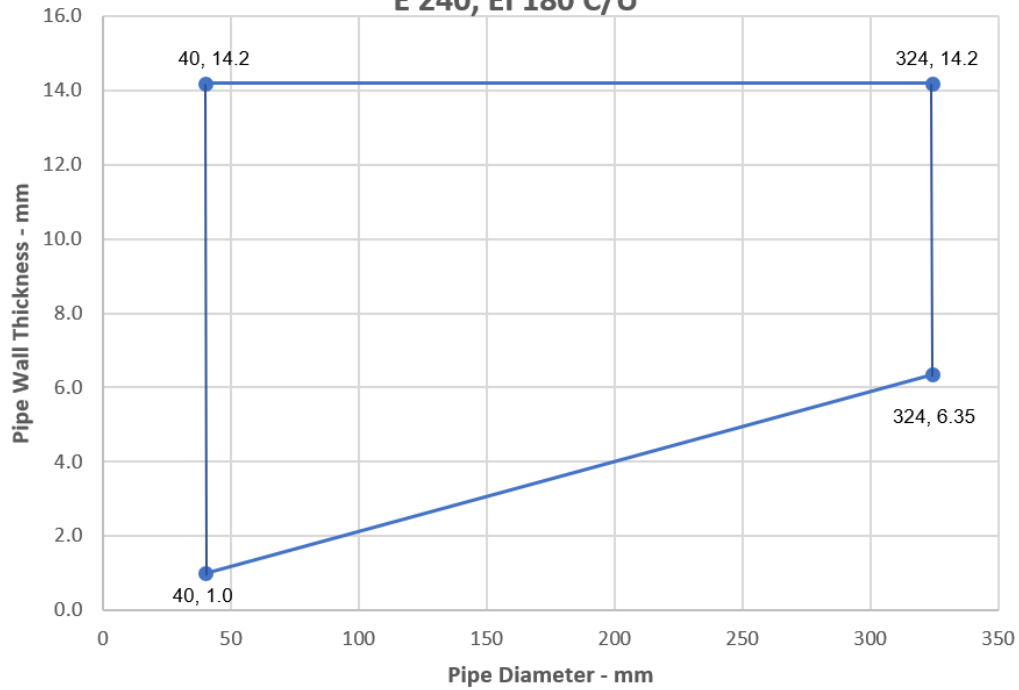

ALUPEX Pipes with 30 mm Thick Insulation - EI 240 C/C

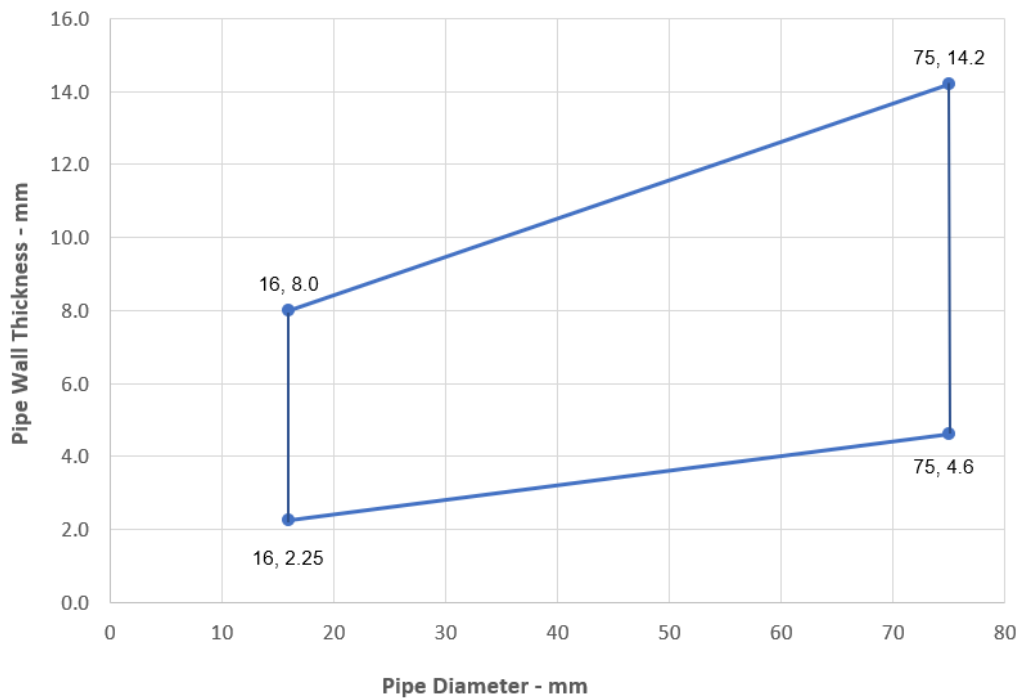

Declaration of Performance
SikaSeal-632 Fire Putty+
30816702
2021.12 , ver. 1
1549

Template for translation. Only for
internal use

A.4 Rigid floor constructions with floor thickness of minimum 150 mm

A.4.1 Single sided penetration seal with cables

Penetration Seal: Cables (single or bundled up to 50 mm Ø) penetrating through a rigid floor construction and fitted at any position within the aperture, sealed with a 15mm diameter cord of SikaSeal-632 Fire Putty+ on the top face of the floor. Maximum annular space 10 mm (A1) and minimum separation between penetration seals 30 mm (A2). When incorporating blank penetration seals, the aperture is sealed with 15mm wide by 15mm thick cord of SikaSeal-632 Fire Putty+, applied flush with the bottom face of the floor.

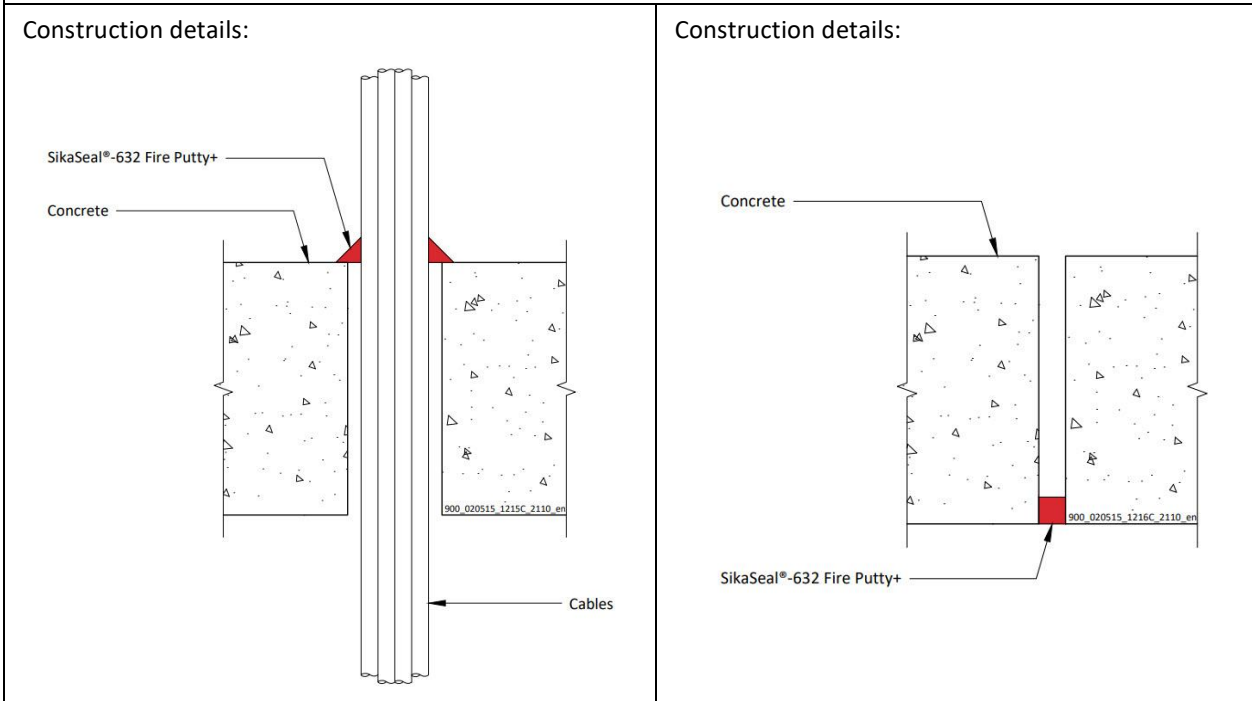

A.4.1.1

Services	Classification
None (blank)	E 120, EI 30
Cables up to 21 mm diameter in tied bundles up to 50 mm diameter*	E 120, EI 60
Cables up to 21 mm diameter*	EI 120
Cables 22-50 mm diameter*	E 120, EI 90
Cables 51-80 mm diameter*	E 120, EI 60
Single 'A1' type cable*	EI 240
Single 'C3' type cable*	EI 240
Single 'E' type cable*	EI 120
Single 'D1' type cable*	EI 120
Single 'D2' type cable*	EI 120
Single 'D3' type cable*	E 240, EI 60

* Cable specification from EN 1366-3 standard cable configuration

Declaration of Performance

SikaSeal-632 Fire Putty+
30816702
2021.12, ver. 1
1549

Template for translation. Only for
internal use

A.4.2 Single sided penetration seal with cables

Penetration Seal: Cables (single or bundled up to 75 mm \varnothing) penetrating through a rigid floor construction and fitted at any position within the aperture, sealed with a 15mm diameter cord of SikaSeal-632 Fire Putty+ on the bottom face of the floor. Maximum annular space 10 mm (A1) and minimum separation between penetration seals 30 mm (A2). When incorporating blank penetration seals, the aperture is sealed with 15mm wide by 15mm thick cord of SikaSeal-632 Fire Putty+, applied flush with both faces of the floor.



A.4.2.1

Services	Seal size	Classification
None (blank)	15mm deep	EI 120
Cables up to 21 mm diameter in tied bundles up to 75mm diameter*	15 mm diameter cord	E 60, EI 45
Cables up to 21 mm diameter*		E 120, EI 60
Cables 22-80 mm diameter*		E 90, EI 45

* Cable specification from EN 1366-3 standard cable configuration

Declaration of Performance
 SikaSeal-632 Fire Putty+
 30816702
 2021.12 , ver. 1
 1549

Template for translation. Only for
 internal use

A.4.3 Double sided penetration seal with cables

Penetration Seal: Cables (single or bundled up to 50 mm Ø) penetrating through a rigid floor construction and fitted at any position within the aperture, sealed with a 15mm diameter cord of SikaSeal-632 Fire Putty+ on both sides of the floor. Maximum annular space 10 mm (A1) and minimum separation between penetration seals 30 mm (A2).

Construction details:

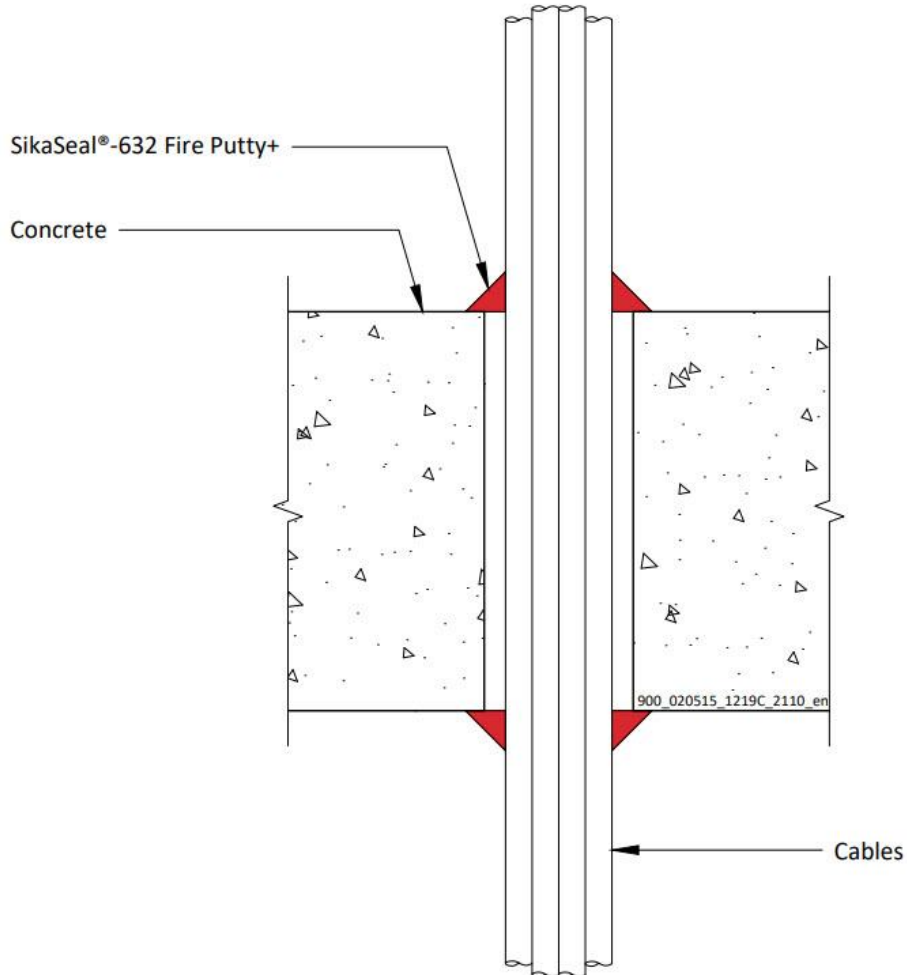

A.4.3.1

Services	Seal size	Classification
Cables up to 21 mm diameter in tied bundles up to 50 mm diameter*	15 mm diameter cord	EI 240

* Cable specification from EN 1366-3 standard cable configuration

Declaration of Performance

SikaSeal-632 Fire Putty+
30816702
2021.12 , ver. 1
1549

Template for translation. Only for
internal use

A.4.4 Single sided penetration seal with metallic pipes

Penetration Seal: Metallic pipes penetrating through a rigid floor construction and fitted at any position within the aperture, sealed with a 15mm diameter cord of SikaSeal-632 Fire Putty+ on the bottom face of the floor. Maximum annular space 10 mm (A1) and minimum separation between penetration seals 30 mm (A2).

Construction details:

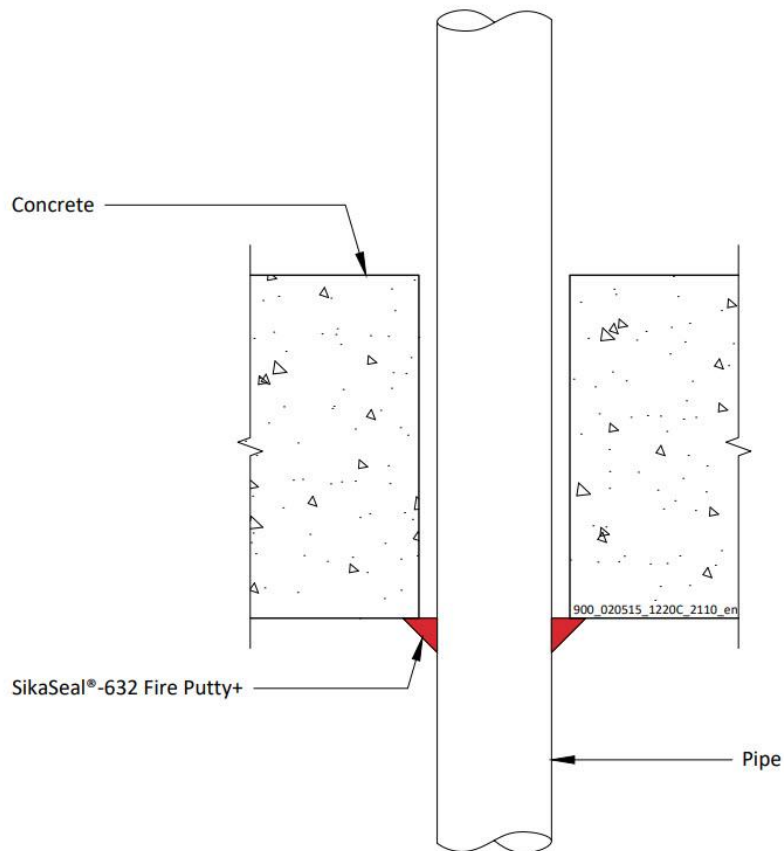

A.4.4.1

Services	Insulation	Classification
Mild or stainless steel pipe		
4 mm diameter*	None needed	EI 120 C/U
5-30 mm diameter*	None needed	E 120, EI 45 C/U
Copper or steel pipe		
6 mm diameter*	None needed	E 120, EI 90 C/C
7-12 mm diameter*	None needed	E 120, EI 30 C/C

*See below graphs for interpolation pipe sizes

Declaration of Performance

SikaSeal-632 Fire Putty+
30816702
2021.12 , ver. 1
1549

Template for translation. Only for
internal use

Steel Pipes - E 120, EI 45 C/U

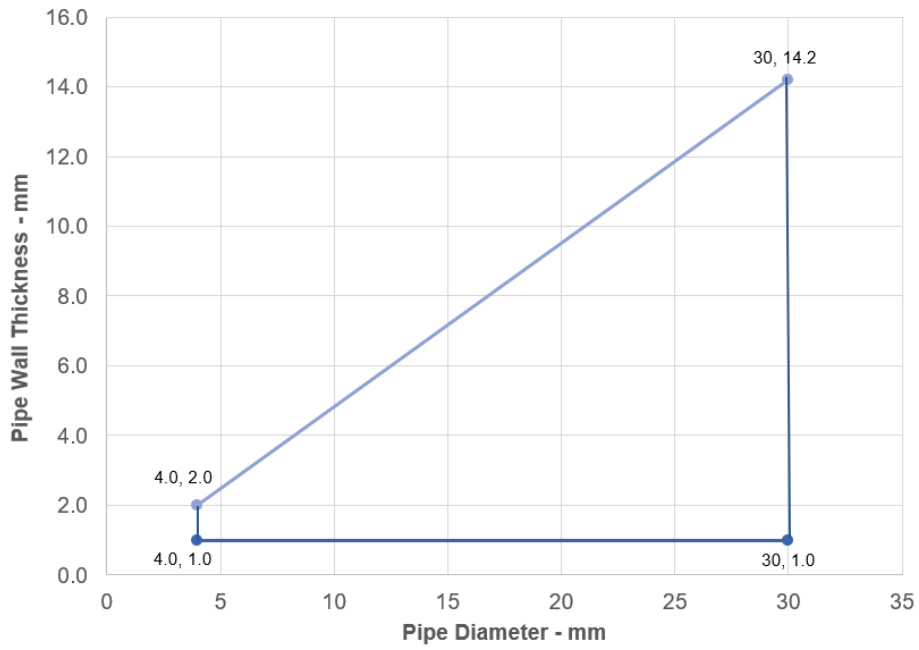

Copper Pipes - E 120, EI 30 C/C

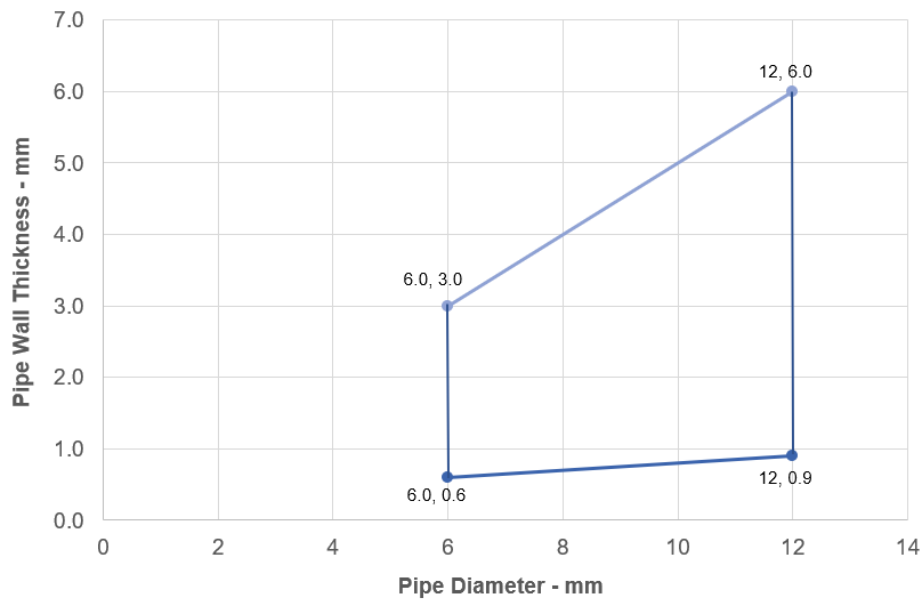

Declaration of Performance
SikaSeal-632 Fire Putty+
30816702
2021.12 , ver. 1
1549

Template for translation. Only for
internal use

A.4.5 Single sided penetration seal with metallic pipes

Penetration Seal: Metallic pipes penetrating through a rigid floor construction and fitted at any position within the aperture, sealed with a 15mm diameter cord of SikaSeal-632 Fire Putty+ on the top face of the floor. Maximum annular space 10 mm (A1) and minimum separation between penetration seals 30 mm (A2).

Construction details:

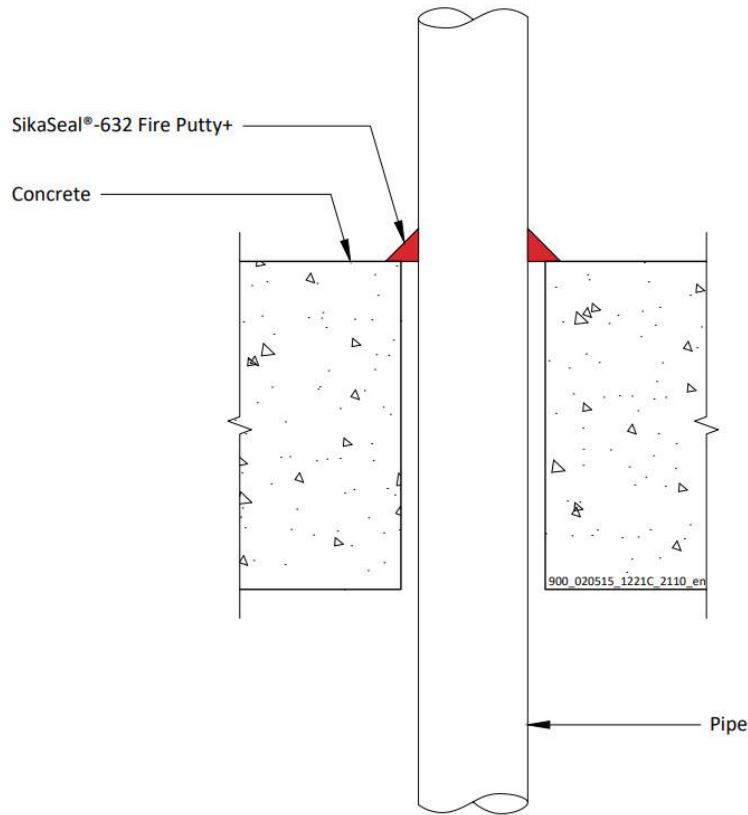

A.4.5.1

Services	Insulation	Classification
Mild or stainless steel pipe		
Maximum 22 mm diameter/1.2-11.0 mm wall*	None needed	EI 120 C/U
Maximum 324 mm diameter/6.35-14.2 mm wall*	None needed	E 240, EI 15 C/U
Copper or steel pipe		
6 mm diameter*	None needed	EI 120 C/C
7-10 mm diameter*	None needed	E 120, EI 90 C/C
Maximum 54 mm diameter/1.2-14.2 mm wall	None needed	E 120 C/C
ALUPEX pipe		
16-20 mm diameter*	None needed	EI 240 C/C
Maximum 75 mm diameter/4.6-14.2 mm wall	None needed	E 45, EI 30 C/C

*See below graphs for interpolation pipe sizes

Declaration of Performance

SikaSeal-632 Fire Putty+
30816702
2021.12 , ver. 1
1549

Template for translation. Only for
internal use

Mild or Stainless Steel Pipes - E 120, EI 15 C/U

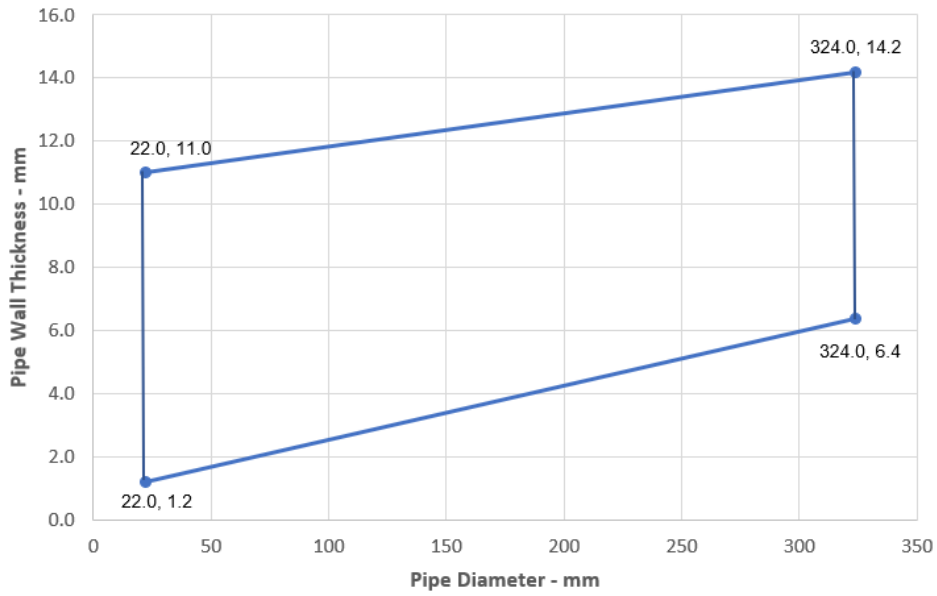

Copper or Steel Pipes - E 120, EI 90 C/C

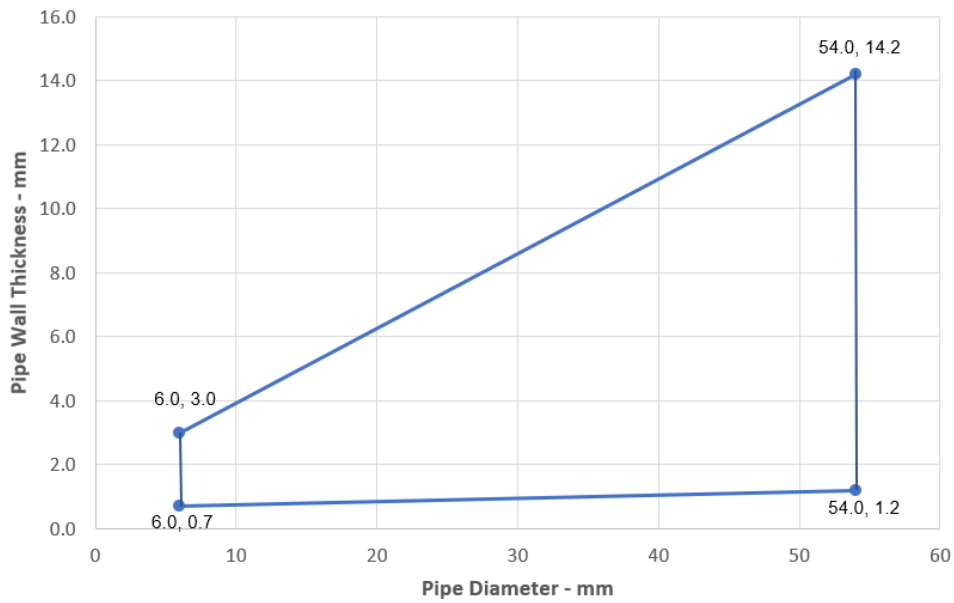

Declaration of Performance
 SikaSeal-632 Fire Putty+
 30816702
 2021.12 , ver. 1
 1549

Template for translation. Only for
 internal use



Alupex Pipes - EI 240 C/C

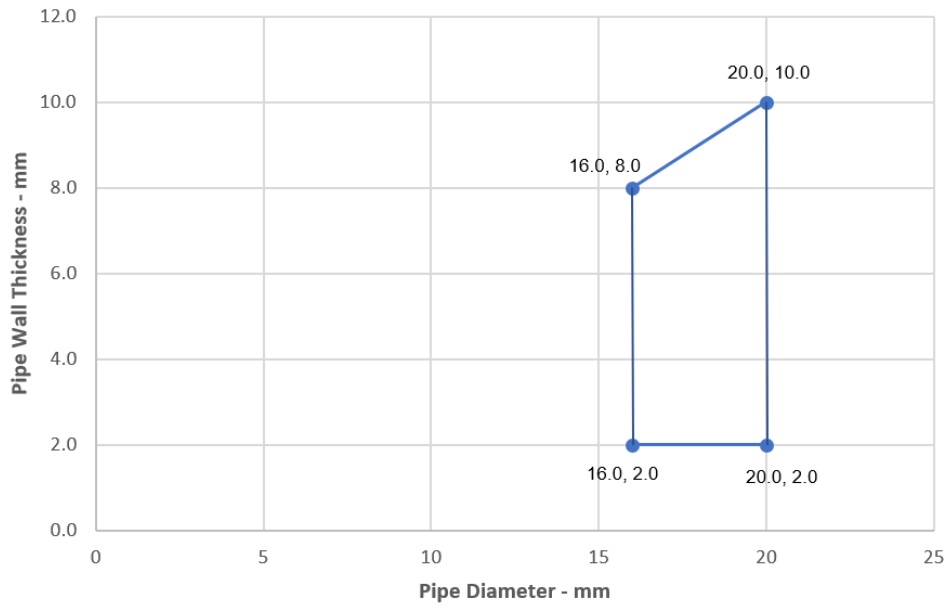

Declaration of Performance
SikaSeal-632 Fire Putty+
30816702
2021.12 , ver. 1
1549

Template for translation. Only for
internal use



A.4.6 Double sided penetration seal with metallic pipes

Penetration Seal: Metallic pipes penetrating through a rigid floor construction and fitted at any position within the aperture, sealed with a 15mm diameter cord of SikaSeal-632 Fire Putty+ on both sides of the floor. Maximum annular space 10 mm (A1) and minimum separation between penetration seals 30 mm (A2).

Construction details:

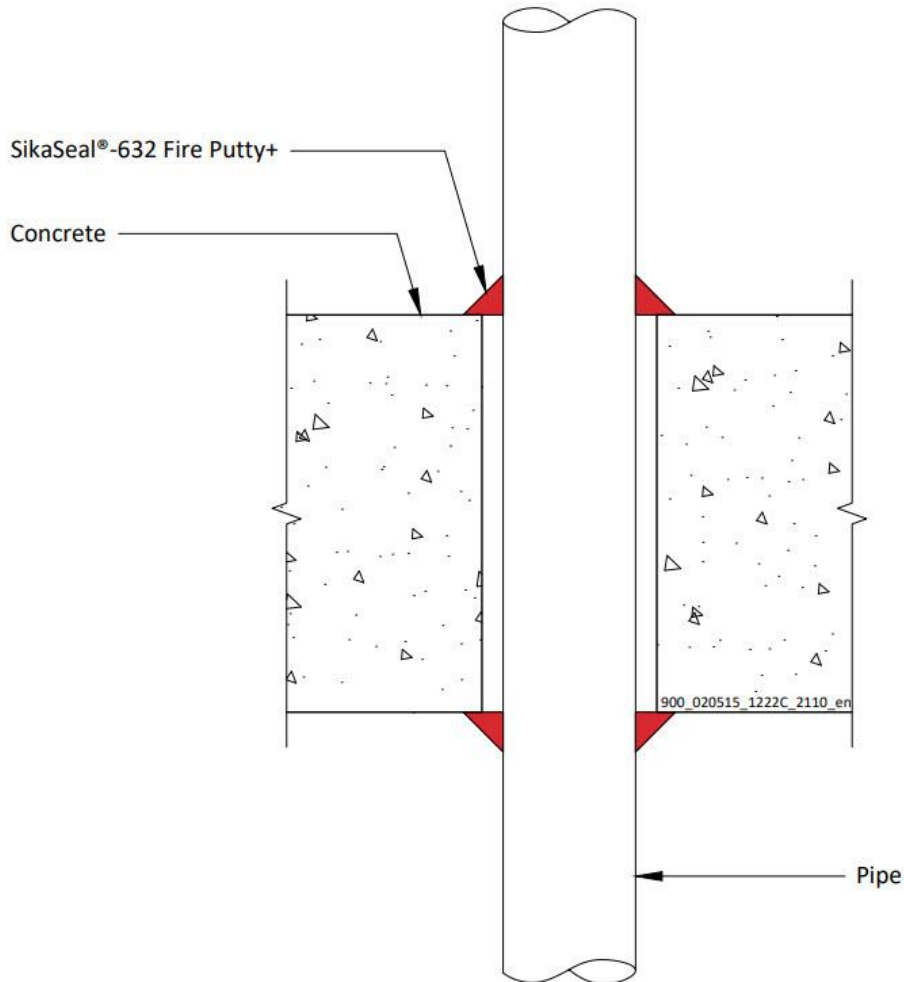

A.4.6.1

Services	Insulation	Classification
Copper or steel pipe		
Maximum 10 mm diameter/0.7-14.2 mm wall	None needed	E 240, EI 180 C/C

Declaration of Performance

SikaSeal-632 Fire Putty+
30816702
2021.12 , ver. 1
1549

Template for translation. Only for
internal use

A.4.7 Single sided penetration seal with insulated metallic pipes, Local Interrupted (LI)

Penetration Seal: Metallic pipes insulated with minimum 80 kg/m³ density mineral wool insulation, Local Interrupted (LI), penetrating through a rigid floor construction, fitted at any position within the aperture, sealed with a 15 mm diameter cord of SikaSeal-632 Fire Putty+ on the top face of the floor. Maximum annular space 10 mm (A1) and minimum separation between penetration seals 30 mm (A2).

Construction details:

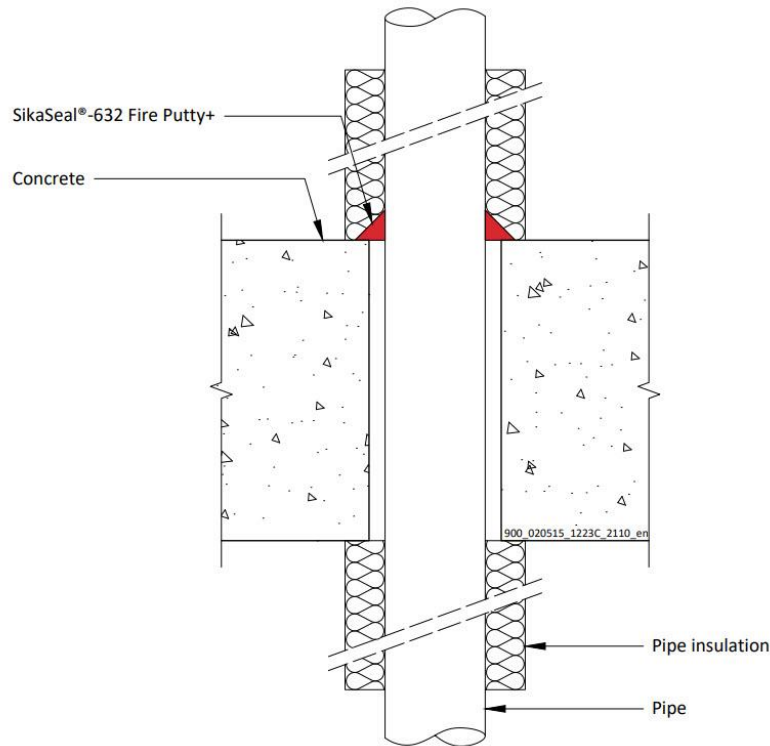

A.4.7.1 Single sided penetration seal with partially insulated metallic pipes

Services	Insulation	Classification
Mild or stainless steel pipe, with minimum 80 kg/m ³ density mineral wool insulation		
Maximum 40 mm diameter*	Minimum 20 mm thick insulation, 500 mm long butted up to each face of the floor	EI 240 C/U
41-324 mm diameter*	Minimum 30 mm thick insulation, 500 mm long butted up to each face of the floor	E 240, EI 60 C/U
ALUPEX pipe with minimum 80 kg/m ³ density mineral wool insulation		
Maximum 16 mm diameter/2.25-8.0 mm wall*	Minimum 20 mm thick insulation, 500 mm long butted up to each face of the floor	EI 240 C/C
Maximum 75 mm diameter/4.6-14.2 mm wall*	Minimum 30 mm thick insulation, 500 mm long butted up to each face of the floor	EI 240 C/C

*See below graphs for interpolation pipe sizes

Declaration of Performance

SikaSeal-632 Fire Putty+
30816702
2021.12, ver. 1
1549

Template for translation. Only for
internal use

Steel Pipes with 30 mm Thick Insulation - E 240, EI 60, C/U

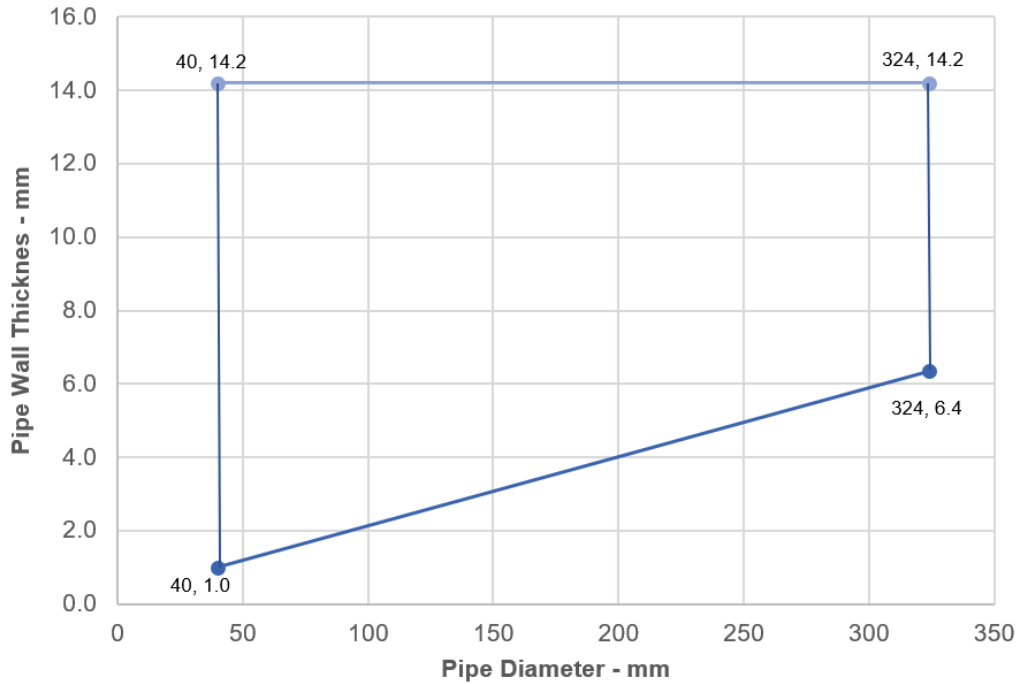

Alupex Pipes with 30 mm Thick Pipe Insulation EI 240 C/C

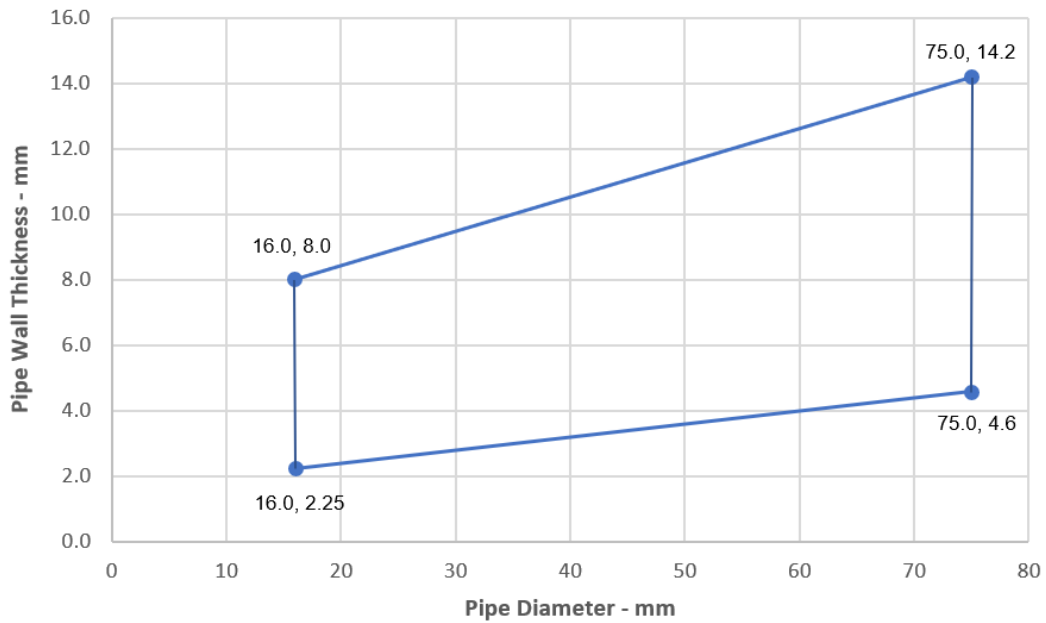

Declaration of Performance
SikaSeal-632 Fire Putty+
30816702
2021.12 , ver. 1
1549

Template for translation. Only for
internal use

A.4.8 Single sided penetration seal with insulated metallic pipes, Local Interrupted (LI)

Penetration Seal: Metallic pipes insulated with minimum 75 kg/m³ density glass or mineral wool insulation, Local Interrupted (LI), penetrating through a rigid floor construction, fitted at any position within the aperture, sealed with a 15 mm diameter cord of SikaSeal-632 Fire Putty+ on the top face of the floor. Maximum annular space 10 mm (A1) and minimum separation between penetration seals 30 mm (A2).

Construction details:

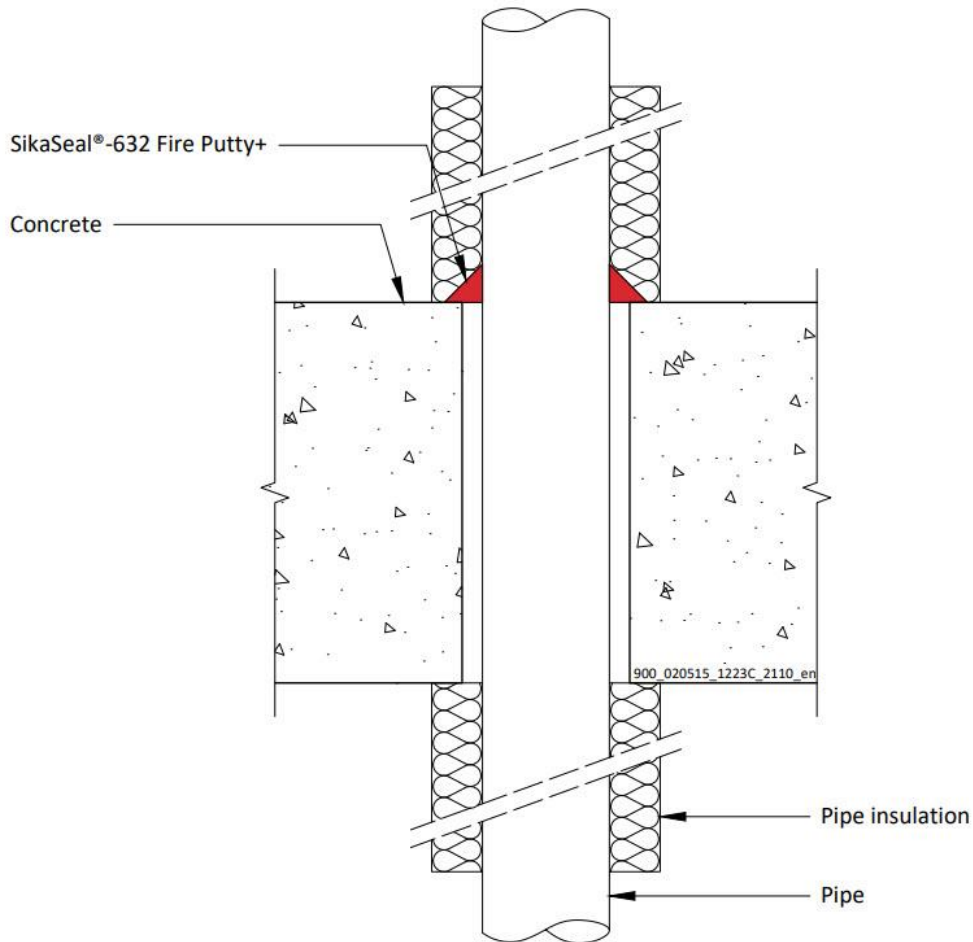

A.4.8.1

Services	Insulation	Classification
Copper or steel pipe with minimum 75 kg/m ³ density glass or mineral wool insulation		
Maximum 12 mm diameter/0.7-14.2 mm wall*	Minimum 20 mm thick insulation, 500 mm long butted up to each face of the floor	EI 240 C/C
Maximum 54 mm diameter/1.2-14.2 mm wall*		E 180, EI 120 C/C

*See below graphs for interpolation pipe sizes

Declaration of Performance

SikaSeal-632 Fire Putty+
30816702
2021.12 , ver. 1
1549

Template for translation. Only for internal use

Copper or Steel Pipes - E 180, EI 120 C/C

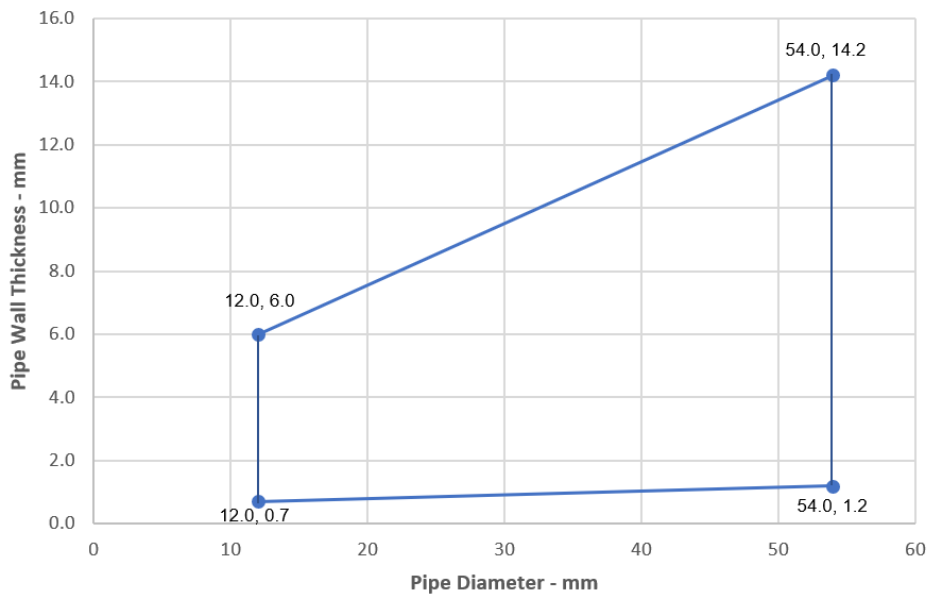

Declaration of Performance
SikaSeal-632 Fire Putty+
30816702
2021.12 , ver. 1
1549

Template for translation. Only for
internal use



A.4.9 Single sided penetration seal with insulated metallic pipes, Continuous Sustained (CS)

Penetration Seal: Metallic pipes insulated with minimum 80 kg/m³ density mineral wool insulation, Continuous Sustained (CS), penetrating through a rigid floor construction, fitted at any position within the aperture, sealed with a 15mm diameter cord of SikaSeal-632 Fire Putty+ on the top face of the floor. Maximum annular space 10 mm (A1) and minimum separation between penetration seals 30 mm (A2).

Construction details:

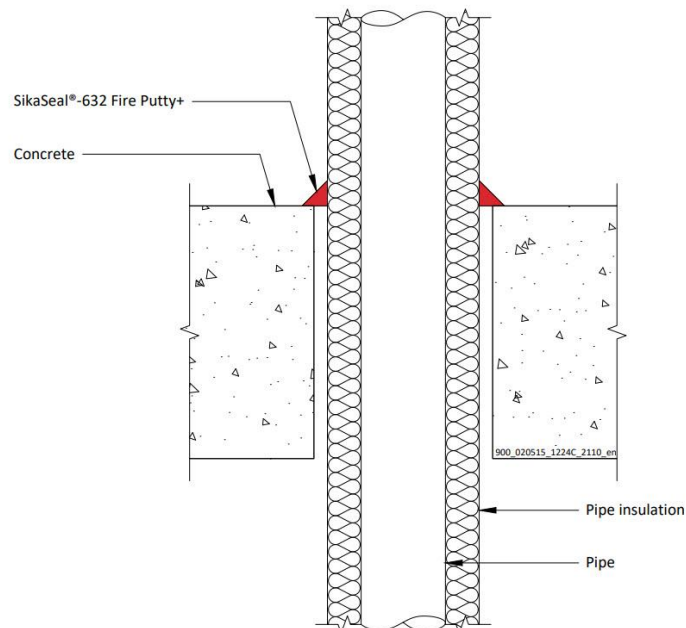

A.4.9.1

Services	Insulation	Classification
Mild or stainless steel pipe, with minimum 80 kg/m ³ density mineral wool insulation		
Maximum 40 mm diameter/1.0-14.2 mm wall	20 mm thick	EI 240 C/U
Maximum 324 mm diameter*	30-80mm thick	EI 240 C/U
Copper or steel pipe with minimum 80 kg/m ³ density mineral wool insulation		
Maximum 12 mm diameter/0.7-6.0 mm wall*	20 mm thick	EI 240 C/C
Maximum 54 mm diameter/1.2-14.2 mm wall*	30-80mm thick	EI 240 C/C
ALUPEX pipe with minimum 80 kg/m ³ density mineral wool insulation		
Maximum 16 mm diameter/2.25-8.0 mm wall*	20 mm thick	EI 240 C/C
Maximum 75 mm diameter/4.6-14.2 mm wall*	30-80mm thick	EI 240 C/C

*See below graphs for interpolation pipe sizes

Declaration of Performance
SikaSeal-632 Fire Putty+
30816702
2021.12, ver. 1
1549

Template for translation. Only for
internal use

Steel Pipes with 30-80 mm Thick Insulation - EI 240 C/U

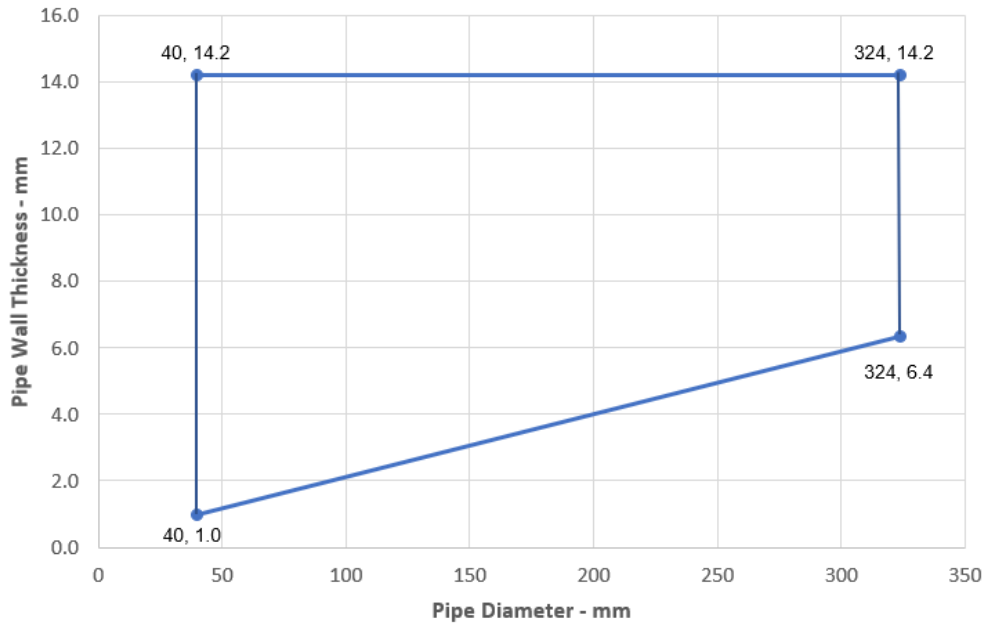

**Copper or Steel Pipes with 30-80 mm Thick Insulation
EI 240 C/C**

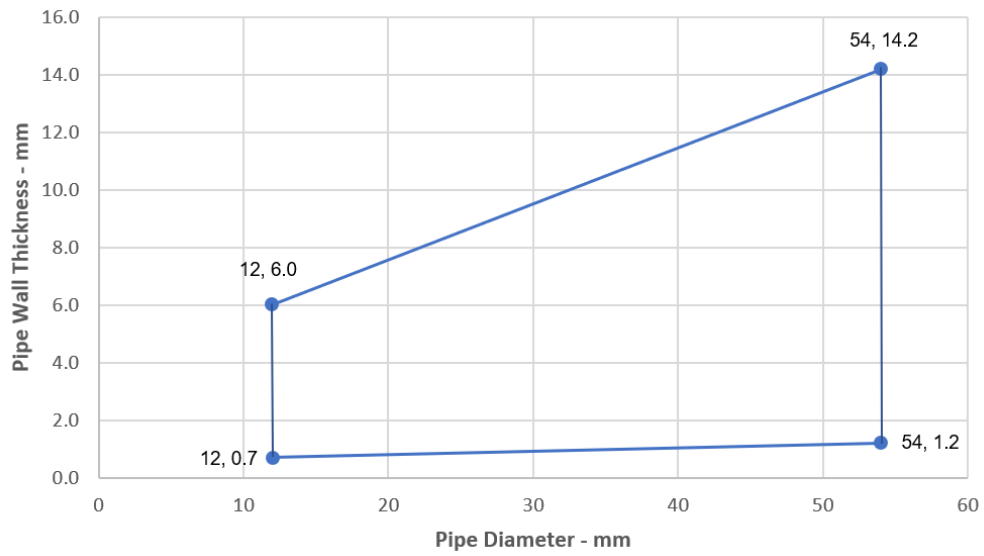

**Alupex Pipes with 30-80 mm Thick Insulation
EI 240 C/C**

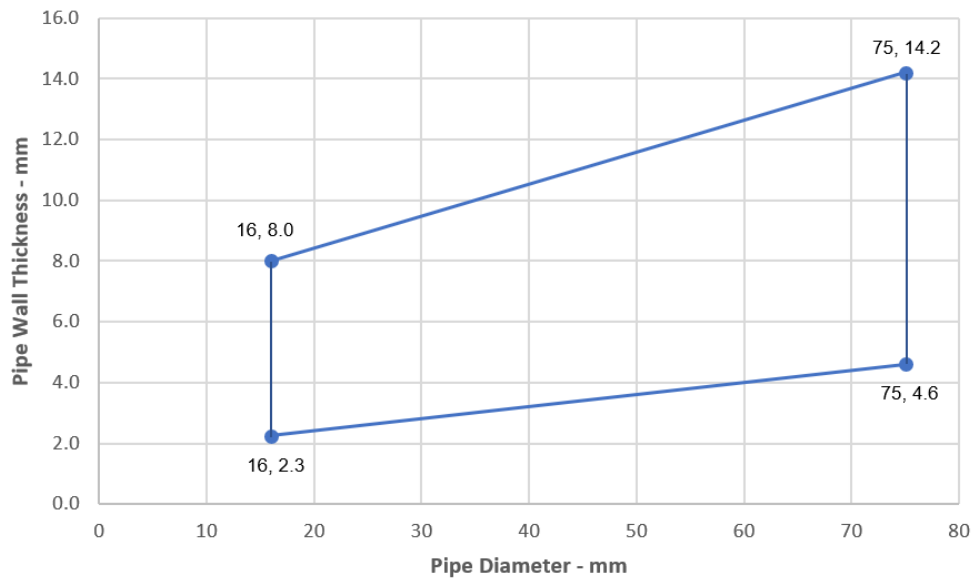

Declaration of Performance
SikaSeal-632 Fire Putty+
30816702
2021.12 , ver. 1
1549

Template for translation. Only for
internal use



A.4.10 Single sided penetration seal with insulated metallic pipes, Continuous Sustained (CS)

Penetration Seal: Metallic pipes insulated with minimum 75 kg/m³ density glass wool insulation, Continuous Sustained (CS), penetrating through a rigid floor construction, fitted at any position within the aperture, sealed with a 15mm diameter cord of SikaSeal-632 Fire Putty+ on the top face of the floor. Maximum annular space 10 mm (A1) and minimum separation between penetration seals 30 mm (A2).

Construction details:

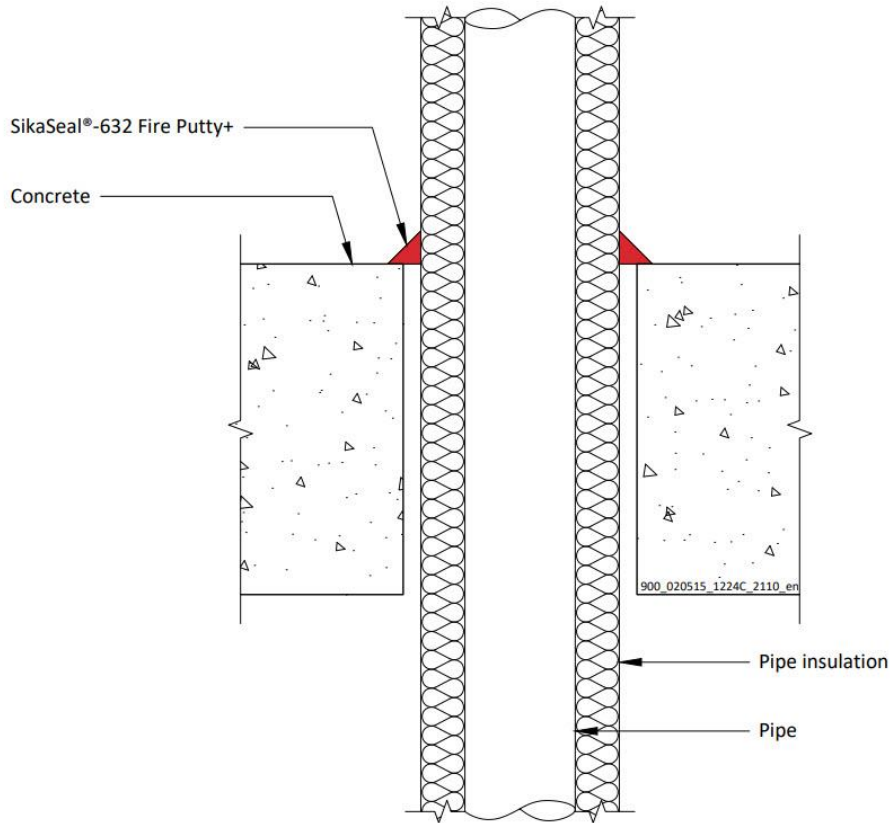

A.4.10.1

Services	Insulation	Classification
Copper or steel pipe with minimum 75 kg/m ³ density glass wool insulation		
Maximum 12 mm diameter/0.7-6.0 mm wall*	20 mm thick	EI 240, EI 90 C/C
Maximum 54 mm diameter/1.2-14.2 mm wall*	20-40mm thick	EI 90 C/C
ALUPEX pipe with minimum 75 kg/m ³ density glass wool insulation		
Maximum 16 mm diameter/2.25-8.0 mm wall*	20 mm thick	EI 120 C/C
Maximum 75 mm diameter/4.6-14.2 mm wall*	20-50mm thick	EI 120 C/C

*See below graphs for interpolation pipe sizes

Declaration of Performance

SikaSeal-632 Fire Putty+
30816702
2021.12 , ver. 1
1549

Template for translation. Only for
internal use

Copper or Steel Pipes - EI 90 C/C

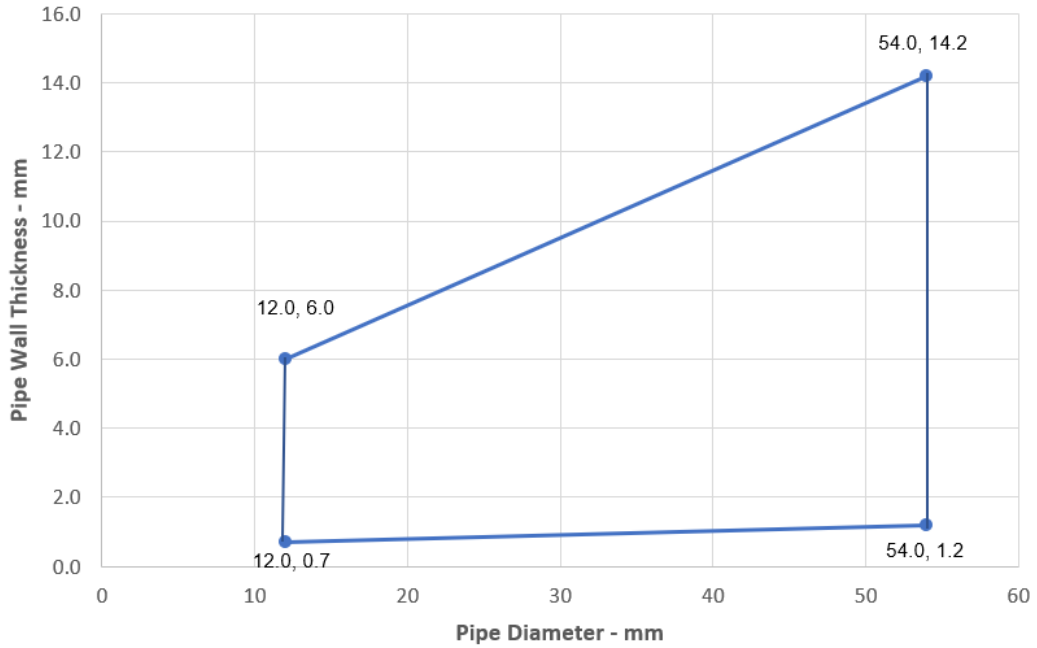

Alupex Pipes - EI 120 C/C

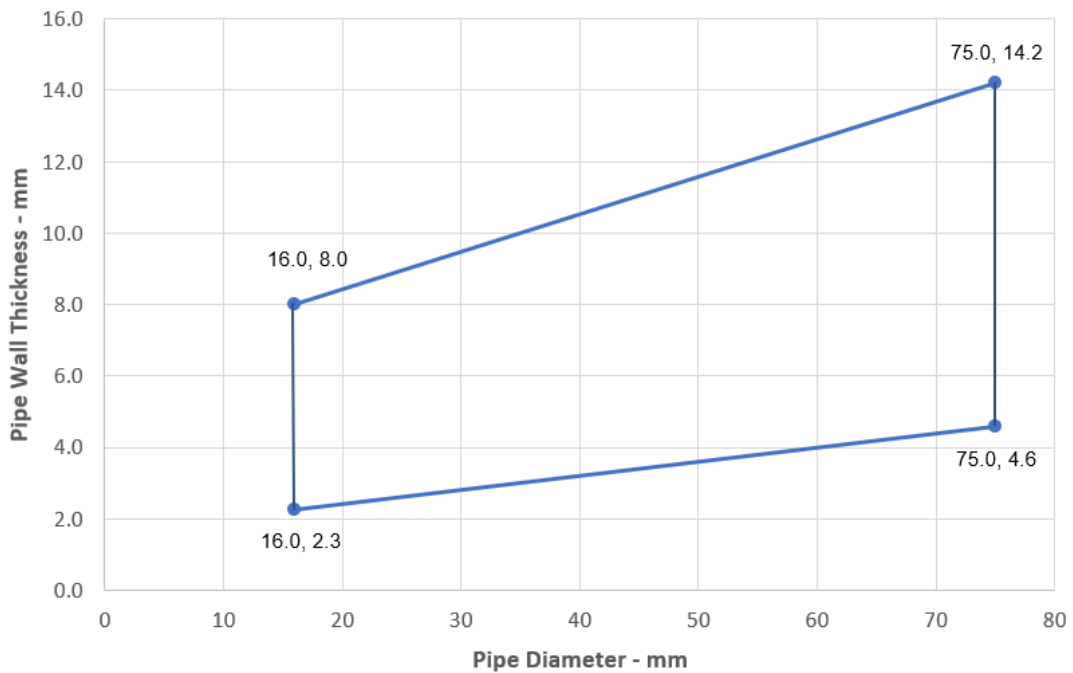

Declaration of Performance
SikaSeal-632 Fire Putty+
30816702
2021.12 , ver. 1
1549

Template for translation. Only for
internal use

ANNEX B – AIR PERMEABILITY – SIKASEAL-632 FIRE PUTTY+

Product tested	SikaSeal-632 Fire Putty+ Cord around 48mm electrical cable in 58mm hole		
Summary of testing procedure		Result	
	Pressure (Pa)	Leakage (m ³ /h)	Leakage (m ³ /m ² /h)
Results under negative chamber pressure	25	0.32	N/A
	50	0.60	N/A
	100	1.00	N/A
	200	1.63	N/A
	300	2.26	N/A
	600	2.64	N/A
	1000	3.25	N/A
Results under positive chamber pressure	25	0.24	N/A
	50	0.26	N/A
	100	0.36	N/A
	200	0.56	N/A
	300	1.11	N/A
	600	1.88	N/A
	1000	2.49	N/A

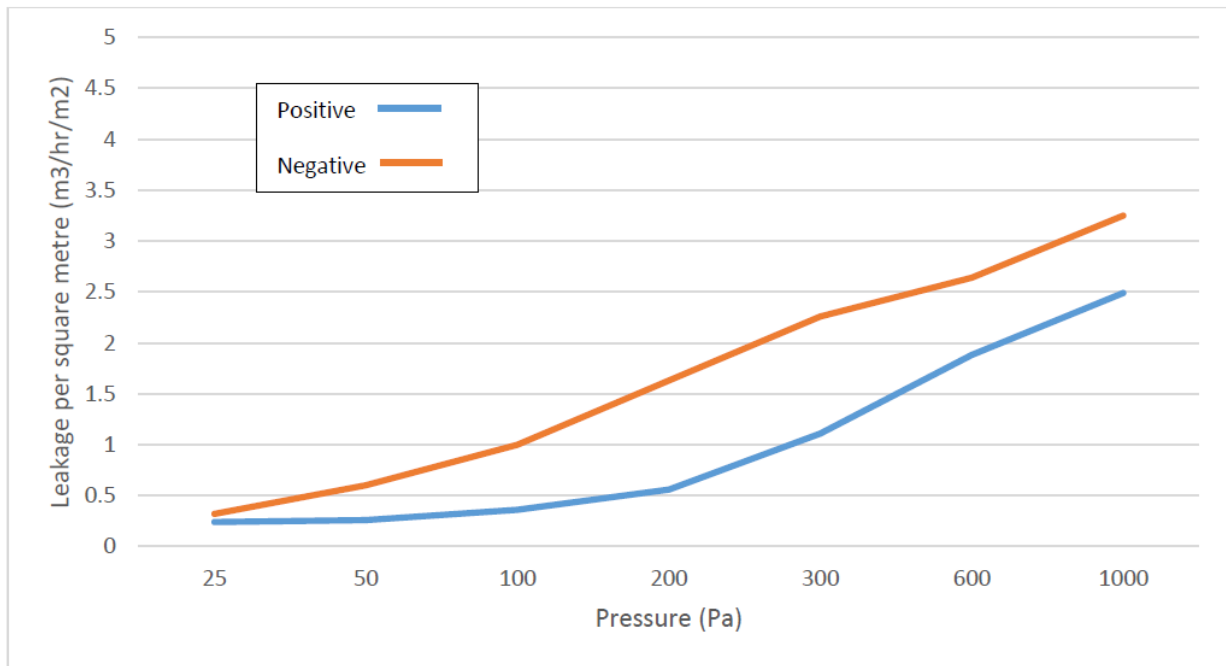

EAD 350454-00-1104:2017
Notified Body 2531
Fire Stopping and Sealing Product: Penetration Seals

<http://dop.sika.com>

Declaration of Performance
 SikaSeal-632 Fire Putty+
 30816702
 2021.12 , ver. 1
 1549

Template for translation. Only for
 internal use

CE MARK TO BE PLACED ON THE LABEL

 21
Sika Services AG, Zurich, Switzerland
30816702
For details see accompanying documents
EAD 350454-00-1104:2017
Notified Body 2531
Fire Stopping and Sealing Product: Penetration Seals

<http://dop.sika.com>

ECOLOGY, HEALTH AND SAFETY INFORMATION (REACH)

For information and advice on the safe handling, storage and disposal of chemical products, users shall refer to the most recent Safety Data Sheet (SDS) containing physical, ecological, toxicological and other safety related data.

LEGAL NOTE

Any information or suggestions for use concerning Sika's products, which we either in writing or orally have given buyers or end-users of the product have been given in good faith based on our own experiences and based of approved praxis and the technological and scientific knowledge on the time of giving such suggestions and information, which are given without any type of guarantees, and which do not lead to any further responsibility from Sika Danmark A/S, besides what is stated in the sales agreement in question. The buyer or end-user should themselves investigate or otherwise make sure that our products are suitable for the use in question and further make sure that the products are kept and used correct and in agreement with the published rules and considering the actual conditions in order to avoid damages or less satisfactory results. Any order is accepted and any deliverance is effected according to the general terms of sales and delivery from Sika Danmark A/S, which are considered known and accepted, and which could be handed out when asked for. Our catalogues are not up-dated automatically. The present product data sheet is only for use in Denmark. Values stated in the present product data sheet should be seen as recommended, unless stated otherwise.

Sika Danmark A/S
Hirsemarken 5
DK-3520 Farum
Denmark
www.sika.dk

Declaration of Performance

SikaSeal-632 Fire Putty+
30816702
2021.12 , ver. 1
1549

Template for translation. Only for
internal use