



CONSTRUCTION
RELIABLE AND DURABLE
SOLUTIONS FOR PARKING
STRUCTURES

BUILDING TRUST



PROTECTION FROM THE BASE- MENT TO THE ROOF

COMPLETE PROTECTION OF PARKING STRUCTURES

Car parks provide protection to thousands of cars every day. However, what about the parking structures themselves? If the structure and building envelopes are not protected, or inadequately protected, this can cause owners and operators many unpleasant and costly surprises. Sika provides high quality products and systems to provide complete protection with no nasty surprises. The schematic below illustrates some of the key problem areas and the Sika solutions outlined in this brochure.



Flooring for ground bearing slabs, **Page 6**

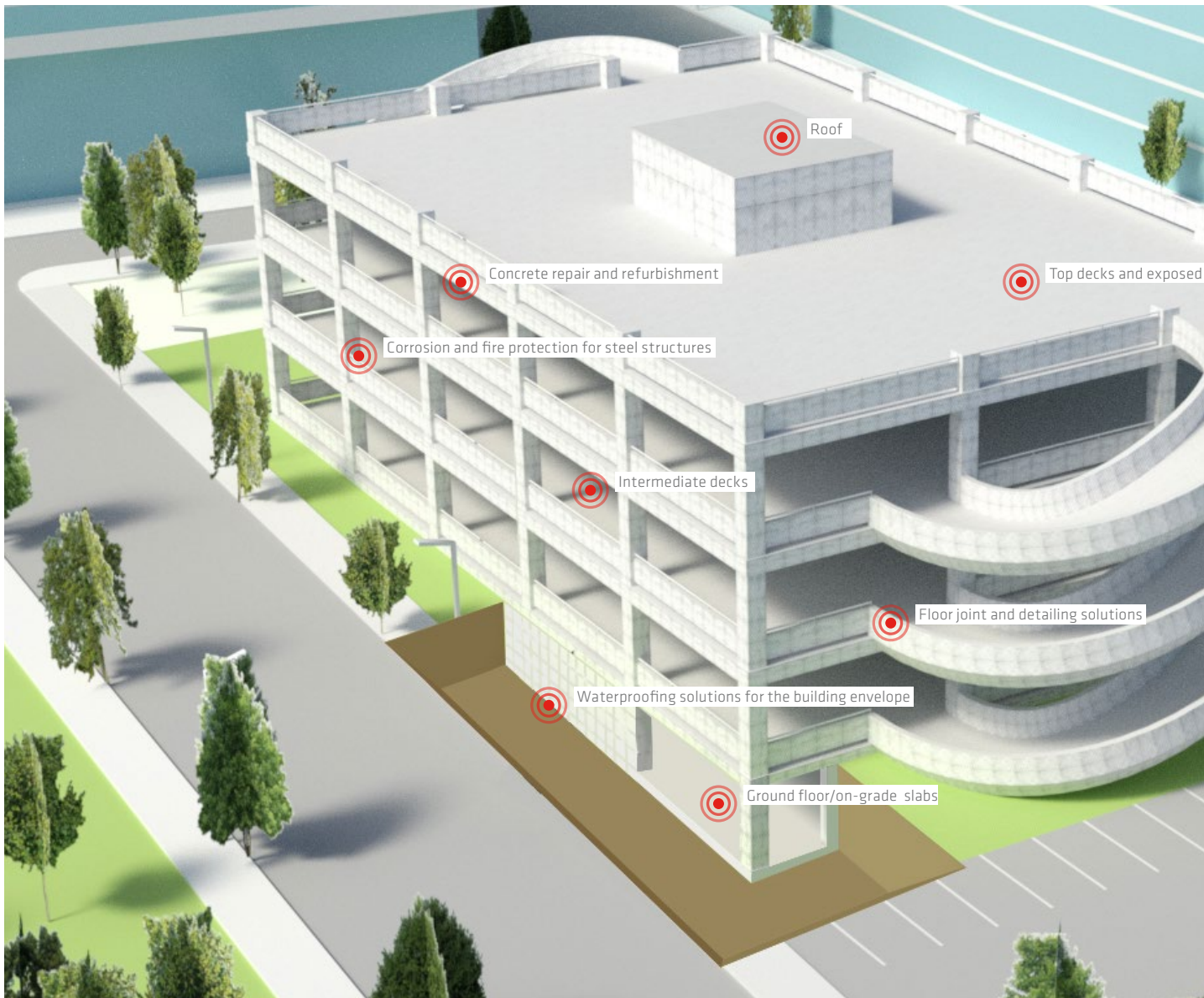



Flooring for intermediate decks, **Page 8**



Flooring for top decks and exposed areas, **Page 12**



Flooring for ramps and entrance areas, **Page 14**



Flooring for entrance areas, walkways and staircases, **Page 18**



Floor joint and detailing solutions, **Page 20**



Corrosion and fire protection for steel structures, **Page 24**

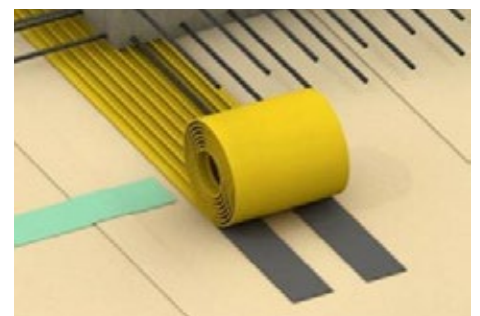

Waterproofing for the building envelope, **Page 26**



Concrete repair and refurbishment, **Page 28**



Roofing, **Page 32**

PARKING STRUCTURES TODAY



INTRODUCTION

Parking has become a vital part of today's mobile community, especially in metropolitan areas including airports, all of which are growing at an ever faster rate. This means continually providing more parking spaces by building new car parks and even more frequently extending and refurbishing existing ones.

Given the choice - Where would you park?

Successful parking structures are designed to meet the users demands, which usually include feeling safe and welcome, plus knowing that their cars are in a secure environment. Given the choice, people always park in bright and well lit car parks, where they feel that they, as well as their car and its contents will be safe and secure.

NEW BUILD

Parking structures are essential and are now fully integrated into modern architectural design. They are frequently built using "fasttrack" construction techniques, with as much off-site construction as possible, to reduce the disruption in urban areas. Therefore precast and prefabricated sections of steel frames with reinforced concrete decks and stairways are usually combined in composite structures for new car parks.

REFURBISHMENT

Most existing multi-storey car parks have been built since the 1950's and they are predominantly of reinforced concrete construction. Many have a long history of early deterioration, structural defects and other shortcomings, which are primarily due to inadequate design, inadequate workmanship, inadequate materials, a lack of maintenance, or very often a combination of all of these factors.

THE EFFECTIVE PROTECTION OF NEW PARKING STRUCTURES WILL PREVENT COSTLY REFURBISHMENT AND MAINTENANCE IN THE FUTURE.



INVESTIGATION AND CONDITION SURVEYS OF EXISTING PARKING STRUCTURES

Parking structures have traditionally been built to 'Building Standards', yet their exposure is frequently similar to that of Civil Engineering structures built to much higher requirements, such as bridges. As a result, relatively rapid deterioration, particularly with reinforcement corrosion due to the ingress of water and de-icing salts, has led to the closure of many areas and even whole car parks, for costly repair, protection and even complete replacement. These bad experiences have served to highlight and emphasise the need for improved design, workmanship and the materials selected to ensure the more durable performance and public safety.

In order to discover the root causes of distress and deterioration in a parking structure, it is always essential to carry out a professional Condition Survey and Assessment, whilst it is obviously also important to balance the cost of this investigative work with the benefits that the results will provide. An appropriate survey is often the key to successfully designing the refurbishment, then maintaining and extending the service life of multi-storey parking structures.

TYPICAL EXPOSURE CONDITIONS IN PARKING STRUCTURES

Multi-storey and also underground car parks are subject to many different stresses from their daily use and exposure including:

- Wide temperature variations and fluctuations
- Rain, driving rain, snow and ice
- Atmospheric carbonation of the concrete
- De-icing salts effects
- Automotive fluids
- Traffic – vehicular and pedestrian
- Structural movement / settlement
- Groundwater

FLOORING SYSTEMS FOR GROUND BEARING SLABS



The epoxy resin based, rigid Sikafloor® MultiDur EB-14 is a standard solution to protect the ground bearing slab. With high wear and chemical resistance it is a cost effective standardised solution for typical ground floors in multi-storey car parks. When lower levels of exposure are anticipated, good protection can also be provided using Sikafloor® HardTop CS-23 W, which creates a monolithic concrete floor finish that is an economic solution for surface hardening and good wear resistance.

In some buildings groundwater pressure can impose additional stress on the ground floor deck coating system from below, which can sometimes appear as blistering in flexible coatings and/or in delamination of larger area. In these situations a water vapor permeable coating system as Sikafloor® MultiDur WB-10, can relieve and accommodate this pressure without adverse effect on the resinous top coating system. Additional the epoxy resin based primers Sikafloor®-160, Sikafloor®-161 and Sikafloor®-701 fulfil EN 13578 as being suitable for use on wet concrete and therefore these can also provide a safe base coat for the desired subsequent resin coating layers.

The 30 year track record of Sikafloor® EpoCem systems providing solutions as as a temporary moisture barrier (TMB) to allow successful resin coating system applications on green or damp concrete, clearly shows the ideal way to achieve durable long term success for applications on such challenging substrates. Sikafloor® EpoCem bonds perfectly to green or hardened concrete, whether dry or damp and uniquely therefore prevents osmotic blistering of resin based coatings over damp substrates. This system is also now known as Sikafloor® MultiDur EB-14 ECC.

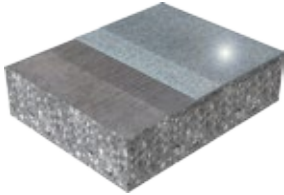
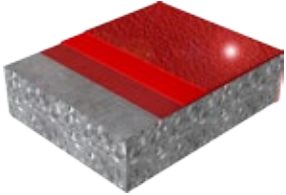
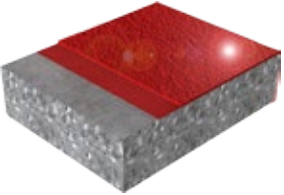
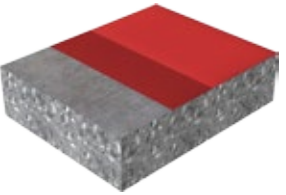

SYSTEM	Sikafloor® HardTop CS-23 W	Sikafloor® MultiDur EB-14 ECC	Sikafloor® MultiDur EB-14	Sikafloor® MultiDur WB-10
				
DESCRIPTION	Monolithic finish for concrete floors	Broadcast unicolor epoxy floor covering thin layer over epoxy hybrid screed	Broadcast unicolor epoxy floor covering	Double water based epoxy roller coat
NOMINAL THICKNESS / LAYERS	< 1 mm 1	2 - 4 mm 3	2 - 3 mm	< 1 mm 2
CHARACTERISTICS	<ul style="list-style-type: none"> ■ Economic surface hardening ■ Good abrasion resistance ■ Good impact resistance ■ Vapor permeable ■ Color options 	<ul style="list-style-type: none"> ■ Cold storage (> -10°C) ■ High wear resistance ■ Good mechanical resistance ■ Medium thermal shock resistance ■ Slip resistance ■ Color options 	<ul style="list-style-type: none"> ■ Cold storage (> -10°C) ■ Highwear resistance ■ Good mechanical resistance ■ Medium thermal shock resistance ■ Meets German Standard OS-8 ■ Slip resistance ■ Color options 	<ul style="list-style-type: none"> ■ Light to medium wear resistance ■ Surface stabilization ■ Prevents surface dusting ■ Color options
SYSTEM COMPONENTS	<ul style="list-style-type: none"> ■ Sikament® or Sika® ViscoCrete® slab ■ Sikafloor®-3 QuartzTop ■ Sikafloor®-ProSeal W / ProSeal 22 	<ul style="list-style-type: none"> ■ Sikafloor®-155 WN or -160 ■ Sikafloor®-81 EpoCem® ■ Quartz sand (0.4 - 0.7 mm) ■ Sikafloor®-264 	<ul style="list-style-type: none"> ■ Sikafloor®-156/-161/-160 ■ Quartz sand (0.4 - 0.7 mm) ■ Sikafloor®-264 	<ul style="list-style-type: none"> ■ Sikafloor® 2540 W ■ Quartz sand (0.4 - 0.7 mm) ■ Sikafloor®-2540 W

FLOORING SYSTEMS FOR INTERMEDIATE DECKS



On intermediate decks the traffic can impart significant and often high stresses on the surface, into the concrete substrate and the whole structure. Therefore tough and rigid systems are used to protect against damage in a cost effective way. Sikafloor® MultiDur EB-24 and the fast curing variants Sikafloor® Pronto RB-25 or RB-28, which are based on methacrylate, are durable deck coating solutions.

In a filigree load carrying structure such as many modern parking structures, cracks are likely to form and then to open and close in the decks. Therefore Sika provides solutions that are elastic and crack-bridging as well as being extremely wear resistant to accommodate these cracks and the abrasive traffic loadings.

The Sikafloor® Multiflex PB-51, PB-52 and PB-54 deck coating systems all meet the stringent German OS 11 a/b certificate standards of high dynamic crack bridging. The Sikafloor® Multiflex PB-21 (OS 13) and PB-32 systems are also tough elastic solutions with good crack bridging abilities for areas with more limited requirements in this respect.

ELASTIC Sikafloor® SYSTEMS



SYSTEM	Sikafloor® MultiFlex PB-21	Sikafloor® MultiFlex PB-51	Sikafloor® MultiFlex PB-52	Sikafloor® MultiFlex PB-54
DESCRIPTION	Broadcast unicolor high performance polyurethane floor covering	Broadcast colored crack bridging system	Broadcast colored crack bridging system	Broadcast car park deck flooring and waterproofing system
NOMINAL THICKNESS / LAYERS	2 - 3 mm 3	3 - 4 mm 3	3 - 5 mm 4	3 - 5 mm 4
CHARACTERISTICS	<ul style="list-style-type: none"> ■ Static crack bridging properties (> -10°C) ■ Meets German Standard OS 13 ■ Abrasion resistance ■ Waterproofing ■ Color options 	<ul style="list-style-type: none"> ■ Wear resistance ■ Waterproofing ■ Slip resistance ■ High flexibility ■ Meets German Standard OS 11b ■ Crack bridging at low temperature ■ Color options 	<ul style="list-style-type: none"> ■ Wear resistance ■ Waterproofing ■ Slip resistance ■ Meets German Standard OS 11a ■ Very high flexibility / crack bridging at low temperature ■ Color options 	<ul style="list-style-type: none"> ■ Wear resistance ■ Slip resistance ■ High flexibility ■ Meets German Standard OS 11a ■ Color options
SYSTEM COMPONENTS	<ul style="list-style-type: none"> ■ Sikafloor®-156/-161/-160 ■ Sikafloor®-375 ■ Quartz sand (0.7 - 1.2 mm) ■ Sikafloor®-378 	<ul style="list-style-type: none"> ■ Sikafloor®-156/-161/-160 ■ Sikafloor®-350 N ■ Quartz sand (0.4 - 0.7 mm) ■ Sikafloor®378 	<ul style="list-style-type: none"> ■ Sikafloor®-156/-161/-160 ■ Sikafloor®-350 N ■ Sikafloor®-375 ■ Quartz sand (0.7 - 1.2 mm) ■ Sikafloor®-378 	<ul style="list-style-type: none"> ■ Sikafloor®-156/-161/-160 ■ Sikalastic®-851 ■ Sikafloor®-375 ■ Quartz sand (0.7 - 1.2 mm) ■ Sikafloor®-378

TOUGH ELASTIC AND RIGID Sikafloor® SYSTEMS



FAST ELASTIC Sikafloor® SYSTEMS

SYSTEM	Sikafloor® MultiFlex PB-32	Sikafloor® MultiDur EB-24	Sikafloor® Pronto RB-25	Sikafloor® Pronto RB-28
DESCRIPTION	Broadcast unicolor tough elastic polyurethane floor covering	Slip resistant broadcast unicolor epoxy floor covering	Elastomeric waterproofing system for flooring applications	Crack bridging waterproofing system for flooring applications
NOMINAL THICKNESS / LAYERS	2 - 3 mm 3	2 - 4 mm 3	3 - 5 mm 3	3 - 5 mm 3
CHARACTERISTICS	<ul style="list-style-type: none"> ■ Static crack bridging properties ■ Abrasion resistance ■ Waterproofing ■ Slip resistance ■ Color options 	<ul style="list-style-type: none"> ■ Cold storage (> -10°C) ■ High wear resistance ■ Good mechanical resistance ■ Slip resistance ■ Color options 	<ul style="list-style-type: none"> ■ Crack bridging ■ Rapid curing ■ Good wear resistance ■ Good chemical resistance ■ Slip resistance ■ Color options 	<ul style="list-style-type: none"> ■ Rapid curing ■ Crack bridging ■ Medium wearing resistance ■ Waterproofing ■ Slip resistance ■ Color options
SYSTEM COMPONENTS	<ul style="list-style-type: none"> ■ Sikafloor®-156/-161/-160 ■ Sikafloor®-3240/-324 ■ Quartz sand (0.4 - 0.7 mm) ■ Sikafloor®-378 	<ul style="list-style-type: none"> ■ Sikafloor®-156/-161/-160 ■ Sikafloor®-263 SL ■ Quartz sand (0.4 - 0.7 mm) ■ Sikafloor®-264 	<ul style="list-style-type: none"> ■ Sikafloor®-10/-11/-13 Pronto ■ Sikafloor®-15 Pronto ■ Quartz sand (0.7 - 1.2 mm) ■ Sikafloor® 18-Pronto 	<ul style="list-style-type: none"> ■ Sikafloor®-10/-11/-13 Pronto ■ Sikafloor®-32 Pronto ■ Quartz sand (0.7 - 1.2 mm) ■ Sikafloor®-18 Pronto



FLOORING SYSTEMS FOR TOP DECKS AND EXPOSED AREAS



Because of their exposure to the elements, the top decks and externally exposed areas of parking structures suffer not only from the diverse stresses of vehicular traffic and chemical attack, but the seasonal and daily thermal variations and fluctuations which cause significant dimensional changes in the structure and its components. The Sikafloor® parking structure systems are specifically designed to accommodate and where possible to absorb this stress and ensure the waterproofing and protection are maintained durably over time. In these exposed areas it is of course very important to properly plan the drainage and also the color of the decks. Lighter colors have higher solar reflectance and can therefore help in keeping a building cool. Sika provides system solutions for every application area and exposure requirements.

Highly crack bridging systems based on polyurethane resin, are Sikafloor® Multiflex PB-51 UV, PB-52 UV and PB-54 UV, which have UV stable top coats and also good color retention over time.

Additionally, in order to be as weather independent as possible during the application period or when a fast return to service during refurbishment is needed, Sika also provides alternative rapid hardening, methacrylate based coating systems, Sikafloor® Pronto RB-28 and RB-55, plus the highest performance Sikafloor® Pronto RB-58 system. This system has the highest dynamic crack bridging capabilities in accordance with class B 4.2 of DIN -EN 1062-7 in combination with its tough and resilient, UV resistant top coat.

ELASTIC Sikafloor®



SYSTEM

Sikafloor® MultiFlex PB-52 UV

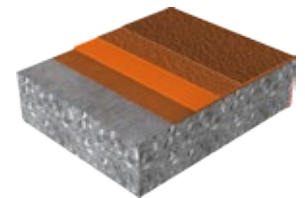

DESCRIPTION

Broadcast car park deck flooring and waterproofing system with UV sealer

NOMINAL THICKNESS / LAYERS

3 - 5 mm
4

CHARACTERISTICS

- Dynamic and static crack bridging properties (> -20°C)
- Meets German Standard OS-11a
- Abrasion resistance
- Waterproofing
- Color options

SYSTEM COMPONENTS

- Sikafloor®-156/-161/-160
- Sikafloor®-350 N
- Sikafloor®-375
- Quartz sand (0.7 - 1.2 mm)
- Sikafloor®-359 N

SYSTEMS

FAST ELASTIC Sikafloor® SYSTEMS



Sikafloor® MultiFlex PB-51 UV

Sikafloor® MultiFlex PB-54 UV

Sikafloor® Pronto RB-28

Sikafloor® Pronto RB-55

Sikafloor® Pronto RB-58

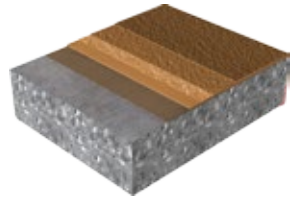
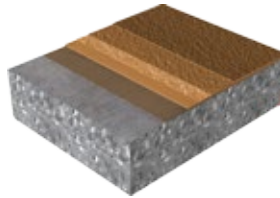
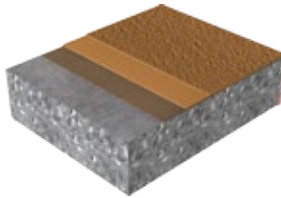
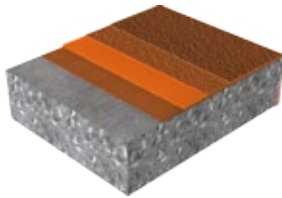
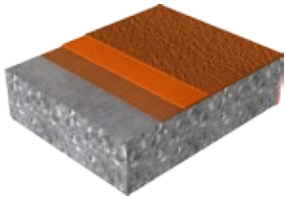

Broadcast colored crack bridging system with UV sealer

Broadcast car park deck flooring and waterproofing system with top sealer over elastic membrane

Crack bridging waterproofing system for flooring applications

Highly elastomeric waterproofing system for flooring applications

Extremely crack bridging waterproofing system for flooring applications

3 - 4 mm

3 - 5 mm

3 - 5 mm

5 - 7 mm

5 - 7 mm

3

4

3

4

4

- Dynamic and static crack bridging properties (> -20°C)
- Meets German Standard QS-11b
- Abrasion resistance
- Waterproofing
- Color options

- Wear resistance
- Slip resistance
- High flexibility
- UV stability
- Color options

- Rapid curing
- Crack bridging
- Medium wearing resistance
- Waterproofing
- Slip resistance
- Color options

- Highly crack bridging
- Rapid curing
- Good wear resistance
- Good chemical resistance
- Slip resistance
- Color options

- Dynamic and static crack bridging properties (> -20°C)
- Extremely crack bridging, low temperature flexibility
- Meets German Standard QS-10
- Waterproofing
- Slip resistance
- Color options

- Sikafloor®-156/-161/-160
- Sikafloor®-350 N
- Quartz sand (0.4 - 0.7 mm)
- Sikafloor®-359 N

- Sikafloor®-156/-161/-160
- Sikalastic®-851
- Sikafloor®-375
- Quartz sand (0.7 - 1.2 mm)
- Sikafloor®-359 N

- Sikafloor®-10/-11/-13 Pronto
- Sikafloor®-32 Pronto
- Quartz sand (0.7 - 1.2 mm)
- Sikafloor®-18 Pronto

- Sikafloor®-10/-11/-13 Pronto
- Sikafloor® 15 Pronto
- Sika® Reemat Premium
- Sikafloor® 15 Pronto
- Quartz sand (0.7 - 1.2 mm)
- Sikafloor®-18 Pronto

- Sikafloor®-10/-11/-13 Pronto
- Sikafloor®-32 Pronto
- Sika® Reemat Premium
- Sikafloor®-32 Pronto
- Quartz sand (0.7 - 1.2 mm)
- Sikafloor®-18 Pronto

FLOORING SYSTEMS FOR RAMPS AND ENTRANCE AREAS



Car park entrances and ramps usually have the highest traffic loading in terms of frequency, braking and acceleration, sometimes in combination with higher speeds, which dictate the need for the highest resistance and durability against this stress. High slip resistance is frequently an additional requirement in these areas, in order to prevent cars from crashing into kerbs, walls or barriers. Sikafloor® MultiDur EB-14 is a cost effective and tough, rigid system designed to withstand these high demands. The polyurethane resin based Sikafloor® Multiflex PB-32 is a tough elastic system which can also absorb some significant movement of the structure.

The ramps and entrance areas are often sections that cannot be closed or blocked off for maintenance works, or if they can, then only for a very short time. For refurbishment works in these areas the very fast curing and tough elastic Sikafloor® Pronto RB-25 and RB-55 systems, are ideal and enable the areas to be put back in to service with the minimum of delay.

The unique Sikafloor® OneShot PB-55 and PB-55 UV systems are the ultimate problem solvers on the market for this type of critical application. They combine the performance properties of a top quality deck coating with the speed of application of a spray applied polyurea membrane and the whole system build-up is completed in less than one day and trafficable after just a few hours. The Sikafloor® OneShot system properties in service also exceed the performance requirements in terms of wear resistance, crack bridging and durability for a long service-life.

Contact your local Sika technical department to help design and specify the right system, tailored to your specific needs and requirements for application and service in each area.

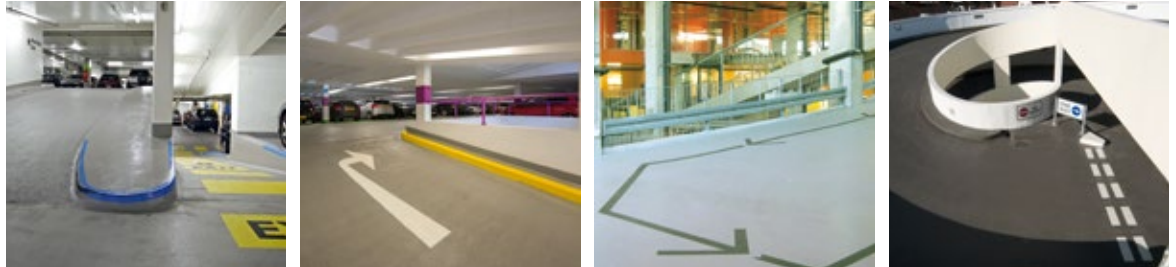

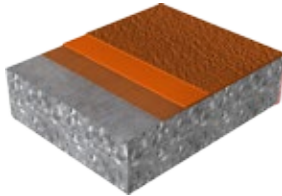
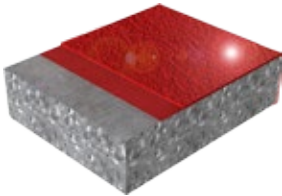
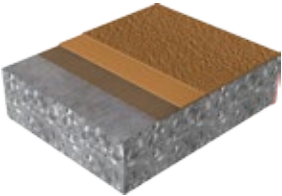
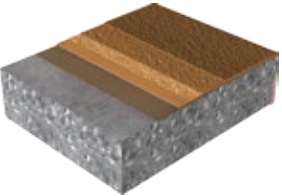
SYSTEM	Sikafloor® MultiFlex PB-32	Sikafloor® MultiDur EB-14	Sikafloor® Pronto RB-25	Sikafloor® Pronto RB-55
				
DESCRIPTION	Broadcast unicolor tough elastic polyurethane floor covering with UV sealer	Broadcast unicolor epoxy floor covering	Elastomeric waterproofing system for flooring applications	Highly elastomeric waterproofing system for flooring applications
NOMINAL THICKNESS / LAYERS	2 - 3 mm 3	2 - 3 mm	3 - 5 mm 3	5 - 7 mm 4
CHARACTERISTICS	<ul style="list-style-type: none"> ■ Static crack bridging properties ■ Abrasion resistance ■ Slip resistance ■ Color options ■ UV stability 	<ul style="list-style-type: none"> ■ Cold storage (> -10°C) ■ Highwear resistance ■ Good mechanical resistance ■ Medium thermal shock resistance ■ Meets German Standard OS-8 ■ Slip resistance ■ Color options 	<ul style="list-style-type: none"> ■ Crack bridging ■ Rapid curing ■ Good wear resistance ■ Good chemical resistance ■ Slip resistance ■ Color options 	<ul style="list-style-type: none"> ■ Highly crack bridging ■ Rapid curing ■ Good wear resistance ■ Good chemical resistance ■ Slip resistance ■ Color options
SYSTEM COMPONENTS	<ul style="list-style-type: none"> ■ Sikafloor®-156/-161/-160 ■ Sikafloor®-3240/-324 Quartz sand (0.4 - 0.7 mm) ■ Sikafloor®-378 N 	<ul style="list-style-type: none"> ■ Sikafloor®-156/-161/-160 ■ Quartz sand (0.4 - 0.7 mm) ■ Sikafloor®-264 	<ul style="list-style-type: none"> ■ Sikafloor®-10/-11/-13 Pronto ■ Sikafloor® 15 Pronto ■ Quartz sand (0.7 - 1.2 mm) ■ Sikafloor® 18-Pronto 	<ul style="list-style-type: none"> ■ Sikafloor®-10/-11/-13 Pronto ■ Sikafloor® 15 Pronto ■ Sika® Reemat Premium ■ Sikafloor® 15 Pronto ■ Quartz sand (0.7 - 1.2 mm) ■ Sikafloor®-18 Pronto

SIKA ONE SHOT PARKDECK SYSTEM

Short Down Time = Money Saving with Innovative Sikalastic®-8800 Spray Applied Injection Technology Combining Polyurea and Aggregates.



PRIMING

8:00 h

Priming with the ultra-rapid Sika®-Concrete Primer and 30 minutes later spraying of the crack-bridging waterproofing membrane Sikalastic®-8800 at a film thickness of 1.5 mm.

INJECTION

11:00 h

Injection of aggregates in the spray pattern of the Polyurea Sikalastic®-8800 in order to install the non-slip surface.

ROLLER APPLICATION

14:00 h

Roller application of the top coat Sikalastic®-8450.

READY TO USE

20:00 h

SYSTEM

Sikafloor® OneShot PB-57 UV

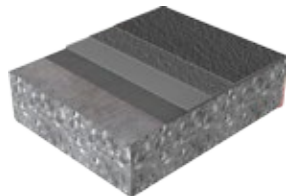

DESCRIPTION

UV resistant, fast curing broadcast high performance polyurethane floor covering with top sealer over elastic membrane

NOMINAL THICKNESS / LAYERS

3 - 5 mm

3

CHARACTERISTICS

- Rapid curing
- High wear resistance
- Waterproofing
- Meets Germann standard OS10
- Slip resistance
- Color options

SYSTEM COMPONENTS

- Sika®-Concrete primer
- Sikalastic®-8800 plus sand
- Quartz sand (0.7 - 1.2 mm)
- Sikalastic®-8450

ADVANTAGE OF THE NEW CARPARK DECK FLOORING SYSTEM

- Time saving
- Material saving
- Short downtime: time need for the new method: 1 day
- Low consumption of aggregate compared to the conventional (manual) method. (approx. 1.5 - 3 kg instead of 6-8 kg)
- Excess of sand does not need to be removed, because the sand is fully bonded
- Lower labor cost
- High durability
- Fast curing
- Highly flexible
- Permanent water and weather resistance
- Slip resistance





FLOORING SYSTEMS FOR ENTRANCE AREAS, WALKWAYS AND STAIRCASES

PEDESTRAIN TRAFFIC

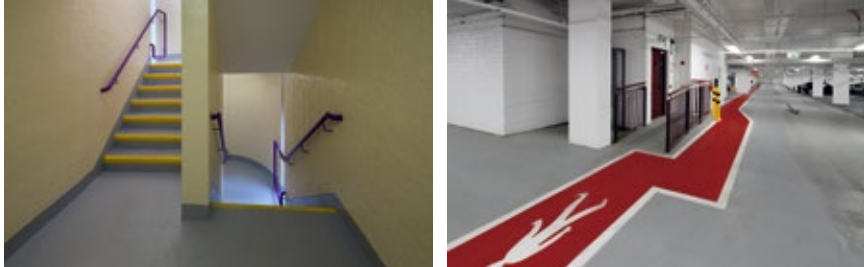

SYSTEM	Sikafloor® MultiDur WS-10	Sikafloor® MultiDur ET-14	Sikafloor® MultiDur EB-24
--------	---------------------------	---------------------------	---------------------------

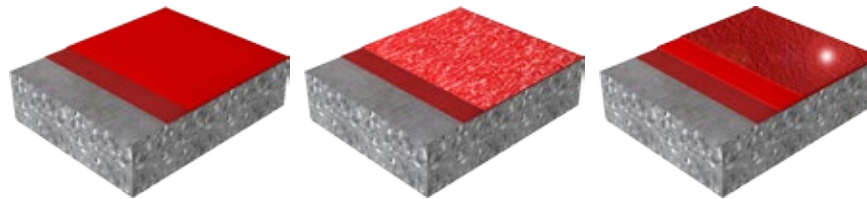

DESCRIPTION	Double water based epoxy roller coats	Textured unicolor epoxy roller coats	Broadcast unicolor epoxy floor covering
--------------------	---------------------------------------	--------------------------------------	---

NOMINAL THICKNESS / LAYERS	< 1 mm 2	< 1 mm 2	2 - 4 mm 3
-----------------------------------	-------------	-------------	---------------

CHARACTERISTICS	<ul style="list-style-type: none"> ■ Light to medium wear resistance ■ Surface stabilization ■ Prevents surface dusting ■ Color options 	<ul style="list-style-type: none"> ■ Good wear and abrasion resistance ■ Good chemical resistance ■ Slip resistance ■ Easy cleaning ■ Color options 	<ul style="list-style-type: none"> ■ Cold storage (> -10°C) ■ High wear resistance ■ Good mechanical resistance ■ Medium thermal shock resistance ■ Slip resistance ■ Color options
------------------------	---	--	--

SYSTEM COMPONENTS	<ul style="list-style-type: none"> ■ Sikafloor®-2540 W ■ Sikafloor®-2540 W 	<ul style="list-style-type: none"> ■ Sikafloor®-156/-161/-160 ■ Sikafloor®-264 Thixo 	<ul style="list-style-type: none"> ■ Sikafloor®-156/-161/-160 ■ Sikafloor®-263 SL ■ Quartz sand (0.4 - 0.7 mm) ■ Sikafloor®-264
--------------------------	--	--	---

PEDESTRAIN TRAFFIC

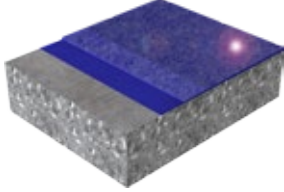
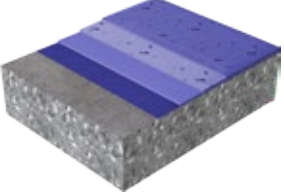
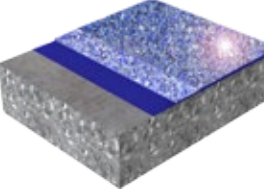

SYSTEM	Sikafloor® DecoDur ES-22 Granite	Sikafloor® DecoDur ES-26 Flake	Sikafloor® DecoDur EB-26 Quartz
			
DESCRIPTION	Smooth low VOC colored granite effect epoxy floor covering	Smooth low VOC colored full flaked epoxy floor covering	Slip resistant low VOC color quartz broadcast epoxy floor covering
NOMINAL THICKNESS / LAYERS	2 - 3 mm 3	2 - 3 mm 4	2 - 3 mm 3
CHARACTERISTICS	<ul style="list-style-type: none"> ■ Food contact compliant ■ Low particle emissions ■ Colored granite effects ■ Designer aesthetics ■ Medium slip resistance optional ■ Low VOC ■ Color options 	<ul style="list-style-type: none"> ■ Food contact compliant ■ Low particle emissions ■ Colored flake effects ■ Medium slip resistance optional ■ Low VOC ■ Color options 	<ul style="list-style-type: none"> ■ Food contact compliant ■ Low particle emissions ■ Colored sand effects ■ Good mechanical resistance ■ Slip resistance ■ Low VOC ■ Color options
SYSTEM COMPONENTS	<ul style="list-style-type: none"> ■ Sikafloor®-264 ■ Sikafloor®-169 ■ Sikafloor®-DecoFiller ■ Sikafloor®-304 W 	<ul style="list-style-type: none"> ■ Sikafloor®-156/-161/-160 ■ Sikafloor®-264 ■ Sika® PVA ColorFlakes (3 mm) ■ Sikafloor®-169 ■ Sikafloor®-304 W 	<ul style="list-style-type: none"> ■ Sikafloor®-156/-161/-160 ■ Sikafloor®-263 SL or -264 ■ Colored quartz sand (0.3 - 0.8 or 0.7 - 1.2 mm) ■ Sikafloor®-169

INNOVATIVE FLOOR JOINT SOLUTIONS

Hardly any vibrations noticeable and rapid return to service

FLOOR JOINTS IN PARKING GARAGE DECKS are a major challenge in both new construction and the refurbishment of existing structures, as their water tightness is one of the key factors for durability. With specially designed connection flanges, Sika® FloorJoint PD and Sika® FloorJoint PDRS are combined with Sikadur® Combiflex® SG to provide 100% watertight movement joints.

As previously mentioned in regard to modern parking structures and customer preference, the environment and aesthetics play an increasingly important role. In addition to creating a lot of undesirable traffic noise, traditional metal edged and mechanical movement joint systems have clear limitations where the joint line and widths are variable or complex in these situations. Also when noise reduction is specifically required the Sika® FloorJoint PD joint panel proves its strengths. This prefabricated carbon fibre reinforced polymer concrete panel fits seamlessly and virtually invisibly into the joints and with the adjacent resin coating systems and floor coverings.

In the difficult areas where ramps and deck / floor slabs connect, vertical movement in these joints can often occur and cause problems; there is also the potential for larger vertical joint movement caused by the extended length of the slabs. In these situations Sika® FloorJoint PDRS is the perfect solution as the concentric integral rubber seal allows for greater movement and at the same time it protects the watertight Sikadur® Combiflex® system from damage.

The top decks of car parks are generally uncovered in most countries and due to the temperature variation (Delta-T) from summer to winter, there will be greater expansion and contraction of the concrete deck slabs than in covered parking decks or underground car parks. The necessary joint locations, dimensions and movement capability must be calculated by the responsible structural engineer, and this then determines the right choice between Sika® FloorJoint PD and PDRS. Normally Sika® FloorJoint PDRS is more suitable for these externally exposed installations because of its higher movement capability.

The STUVA test institute in Cologne has special test equipment to simulate nearly 300'000 vehicle overruns at 50 Km/h, by truck tires with a weight of 10 tonnes. This test is much too severe to simulate a car park environment, but even when tested under these harsh conditions, both Sika® FloorJoint PD and Sika® FloorJoint PDRS achieved top results and remained completely intact.



Sika® FloorJoint PB-30 PD

For gaps in the substrate with a maximum width of 60 mm
(maximum positive joint movement = 40 mm)

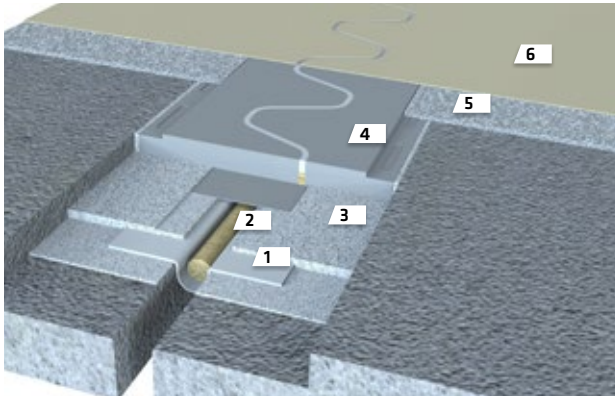

1. Waterproofing	Sikadur®-30 or Sikadur®-31 CF normal + Sikadur® Combiflex® SG-10 P
2. Backing rod	Sika® Backing Rod, size according width of the joint
3. Adhesive	Sikadur®-30 Normal or Sikadur®-31 Normal
4. Floor panel	Sika® FloorJoint PD jointed with Sikaflex® Pro-3
5. Wearing course	e.g. Sikafloor®-156/-161 + Sikadur®-375, broadcast to excess
6. Top coat	e.g. Sikafloor®-359 N

CHARACTERISTICS / ADVANTAGES

- High mechanical and chemical resistance
- Non-corroding
- Waterproof system design possible
- Grindable profile for level integration into the floor surface
- Hardly any vibrations noticeable under direct car or forklift traffic
- Thermal expansion coefficient similar to resin-based floors
- Easy to install / Easy to repair
- Short downtime / Trafficable after 24 h

Sika® FloorJoint PB-30 PDRS

For gaps in the substrate with a maximum width of 50 mm
(maximum positive joint movement = +50 mm)

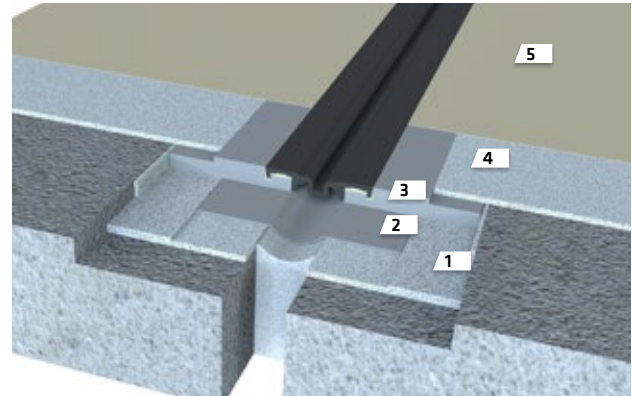

1. Adhesive	Sikadur®-30 or Sikadur®-31 CF normal
2. Waterproofing	Sikadur®-30 or Sikadur®-31 CF normal + Sikadur® Combiflex® SG-10 P
3. Floor panel with rubber seal	Sika® FloorJoint PDRS, the rubber seal is bonded with SikaBond® TF plus N
4. Wearing course	e.g. Sikafloor®-156/-161 + Sikadur®-375, broadcast to excess
5. Top coat	e.g. Sikafloor®-359 N

CHARACTERISTICS / ADVANTAGES

- Exchangable rubber seal
- High mechanical and chemical resistance
- Non-corroding
- Waterproof system design possible
- Grindable profile for level integration into the floor surface
- Hardly any vibrations noticeable under direct car or forklift traffic
- Thermal expansion coefficient similar to resin-based floors
- Easy to install / Easy to repair
- Short downtime / Trafficable after 24 h

DETAILING SOLUTIONS TO LAST

DETAILS, SUCH AS JOINTS, COVING AND DRAINAGE CONNECTIONS need special attention in order to create a fully functioning protective deck coating system. The connections to different construction elements and components are all too frequently overlooked during the project planning stage.

However these are always crucial areas and where we can often find the root cause of leaks and the result can sometimes be a requirement to refurbish the whole building. Furthermore during the deck system application phase, usually towards the end of a building project, the temptation is often there to simplify the proper detailing solutions into something less secure, or even hidden out of sight, and the problems will eventually become apparent at some time in the future.

Investment in detailing solutions in the design office and onsite will be paid back many times over, so always ensure specific design focus and installation time on site for approved detailing solutions.

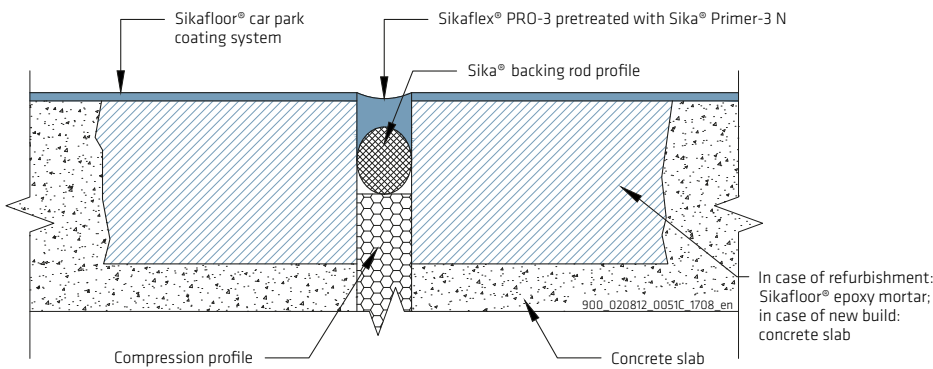

LIGHT WEAR Sikafloor® JOINT SOLUTION WITH Sikaflex® PRO-3

In areas where we don't expect high stress from traffic and we don't have to protect the structure from water we can use a simple joint solution with Sikaflex® Pro-3 sealant. Often used in combination with Sika® Floorjoint for areas with minor stress.

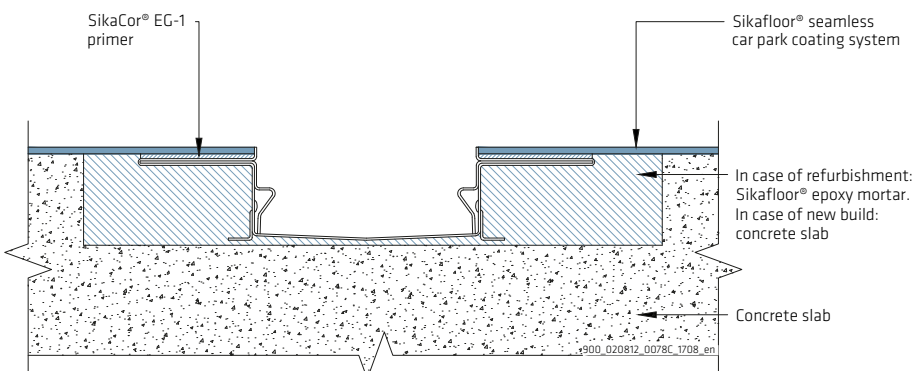

CONNECTION Sikafloor® CAR PARK COATING SYSTEM TO A DRAIN CHANNEL

The connection to a drain is the most crucial connection, because water has to flow there and a failure would lead immediately to a leak. Drains with a flange, e.g. ACO® Deckline s100cf, to overcoat with the Sikafloor® car park coating providing a dense connection and therefore security over time.

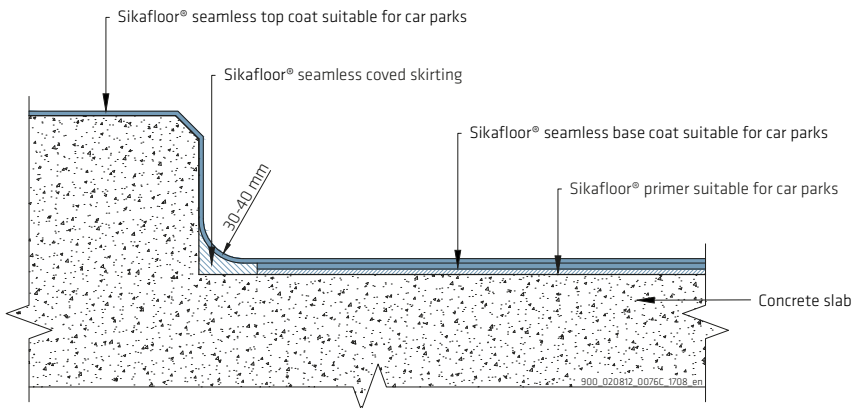

Sikafloor® COATING SOLUTION FOR A CONNECTION TO A FIXED KERB IN A CAR PARK

With the seamless covered skirting the Sikafloor® top coat can be applied seamless from the floor over the whole kerb. An other variant is to use a different color to bring out the kerb.

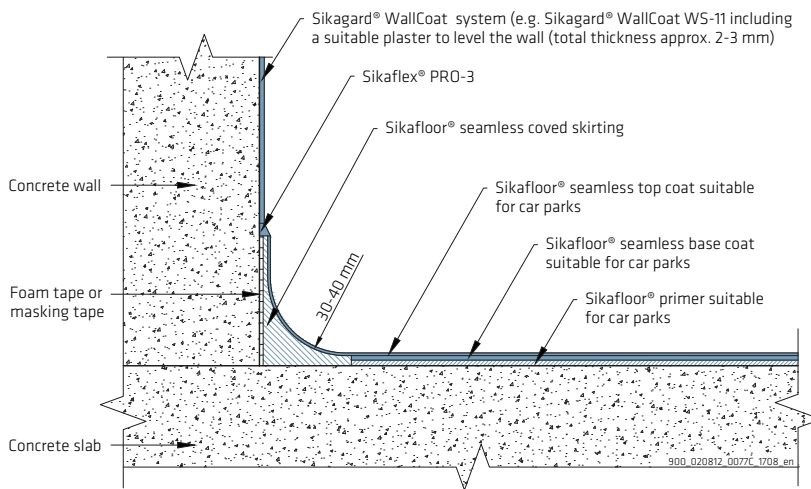

Sikafloor® COVING SOLUTION FOR A FLOOR - WALL CONNECTION WITH EXPECTED MOVEMENT

To connect the Sikafloor® car park coating with a Sikagard® WallCoat often a covered skirting, made of epoxy mortar, is used. It's easy to clean and the floor - wall connection is protected.

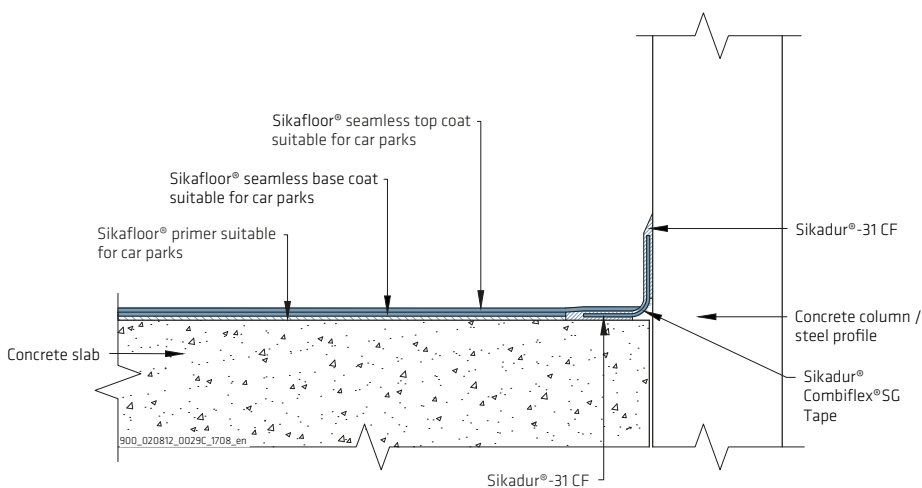

CONNECTION Sikafloor® CAR PARK COATING SYSTEM TO A CONCRETE COLUMN OR STEEL PROFILE WITH EXPECTED MOVEMENT

Connection between two elements, which are subject to movement, can be water-proofed using the Sikadur® Combiflex® System. With its hypalon membrane it ensures durable watertightness.

CORROSION PROTECTION SYSTEMS FOR STEEL PARKING STRUCTURES

CORROSION PROTECTION FOR STEEL PARKING STRUCTURES AND COMPONENTS a durable long-lasting corrosion protection system is required for steel parking structures that is for exposure classified as more severe than just their location. This is due to their open structured design that is open to the elements, plus the aggressive influences of exhaust fumes and possibly automotive fluids, de-icing salts and the vibrations from vehicular traffic.

Therefore, high performance corrosion protection is important for both new build and refurbishment of parking structures, where the materials may have to be applied off-site in the paint shop, or on site in the ambient conditions of the location. Similar corrosion protection coatings are necessary for many other steel components as well as the load bearing structure and ancillary equipment for operation, including all of the parapets, barriers and security fencing, plus any communication masts and other equipment supports, etc.

It can be difficult to make the right price-performance selection of the best optimized corrosion protection coating systems from the numerous ones available in the market, but Sika can guide you through this efficiently. With the SikaCor® and Sika® Permacor® ranges, the right solution is available for every steel coatings application.

Design and aesthetics are also very important, and increasingly so for parking structures as discussed elsewhere in this brochure, so the Sika coatings for the corrosion protection can be supplied in almost any color options to meet the architect's needs.

REQUIREMENTS

SikaCor®-EG System Rapid

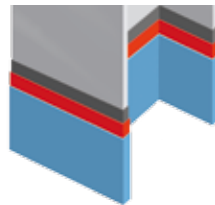
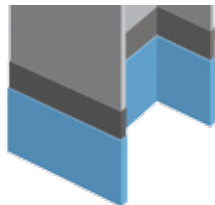

SikaCor®-6630-System

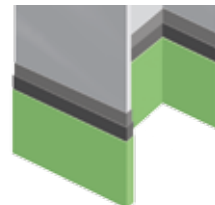

DESIGN / BUILD-UP

- Fast curing, even at temperatures below zero
- High mechanical and chemical resistance
- Manual or spray application on steel
- In accordance with DIN EN 12944
- Designed for application in paint shops

- 1-component high build corrosion protection system
- Easy to apply
- Suitable for application on steel, galvanised steel and as a maintenance system on less than perfectly derusted surfaces
- Designed for application on site

SIKA SYSTEM / PERFORMANCE

Build-up for steel surfaces:

Primer:
SikaCor®-EG 1 Rapid
Top coat:
SikaCor®-EG 4/5 Rapid
DFT: approx. 160 µm
Durable 2-component corrosion protection system for carbon steel and galvanised steel with high aesthetic finish and UV-resistance.

Build-up for steel surfaces:

Primer:
SikaCor®-Friazinc R Rapid
Base coat:
SikaCor®-EG 1 Rapid
Top coat:
SikaCor®-EG 4/5 Rapid
DFT: approx. 240 µm

Build-up for steel surfaces:

Primer:
SikaCor® 6630 high-solid EG
Base coat:
SikaCor® 6630 high-solid EG
Top coat:
SikaCor® 6630 high-solid
DFT: approx. 240 µm
Build up for galvanised steel surfaces:
Primer:
SikaCor® 6630 high-solid EG
Top coat:
SikaCor® 6630 high-solid EG
DFT: approx. 160 µm

Build-up for maintenance:

Primer:
SikaCor® 6630 Primer
Base coat:
SikaCor® 6630 high-solid EG
Top coat:
SikaCor® 6630 high-solid
DFT: approx. 240 µm
1-component corrosion protection system for carbon steel, galvanised steel and existing coatings with aesthetic finish and UV-resistance.

CAR PARK FIRE PROTECTION SYSTEMS FOR STEEL STRUCTURES

SIKA SPRAY APPLIED CEMENTITIOUS FIRE PROTECTION MORTARS can provide long term fire resistance up to 3 hours for steel structures.



REQUIREMENTS	Fire protection for interior steel structures	Fire protection for interior steel structures	Fire protection for exterior steel structures
DESIGN / BUILD-UP	<ul style="list-style-type: none"> ■ Fire resistance up to 180 minutes ■ Protects the steel from heat ■ Thick layer application ■ Applicable on steel and concrete 	<p>Corrosivity class C1, C2 and C3 acc., ISO EN 12944-2</p> <ul style="list-style-type: none"> ■ Fire resistance up to 120 minutes ■ Forms an insulating foam ■ Thin layer application ■ Does not increase static load ■ Applicable on steel and galvanised steel 	<p>Corrosivity class C3, C4 and C5 acc., ISO EN 12944-2</p> <ul style="list-style-type: none"> ■ Fire resistance up to 120 minutes ■ 2 component high build corrosion protection ■ Easy to apply ■ Applicable on steel and galvanised surfaces
SIKA SYSTEM / PERFORMANCE	<p>Build-up for steel surfaces:</p> <p>Primer: Sika® Cementitious Primer</p> <p>Fire protection: Sika® Cementitious Spray Applied Mortar</p> <p>Please refer to your local Sika office, fire protective, spray applied mortars are offered by various Sika companies, in accordance with the local legislation.</p>	<p>Build-up for steel surfaces:</p> <p>Intumescent coat: Sika Unitherm® Platinum</p> <p>Build-up on galvanised steel:</p> <p>Primer: Sika Permacor® 2706 EG</p> <p>Intumescent coat: Sika Unitherm® Platinum</p>	<p>Build-up for steel surfaces and galvanised steel:</p> <p>Primer: Sika® Permacor® 2706 EG</p> <p>Intumescent coat: Sika Unitherm® Platinum</p> <p>Top coat: SikaCor® EG 5</p>

A FULL RANGE OF SOLUTIONS FOR A WATERTIGHT AND SECURE BUILDING ENVELOPE



WATERPROOFING SOLUTIONS FOR UNDERGROUND PARKING STRUCTURES

Sika has over 100 years of experience in providing below ground waterproofing solutions. The selection of the most appropriate waterproofing concept and system for any specific project is dependent on many factors, and it is important to involve a qualified waterproofing specialist at the early stages of design – for both new and refurbishment projects.

Underground car parking areas are no longer just utilitarian spaces, where a dark, damp and uninviting environment is acceptable. So once again to ensure the attractive appearance and an inviting, useable and saleable environment, the waterproofing of your buildings' basement is of the utmost importance, and it is also essential for the smooth operation of an underground car park.

This is in addition to the potentially disastrous consequences of damage caused by water ingress that could result in major additional costs during the life cycle of your structure and even significantly reduce its life span. Fortunately Sika has developed secure, proven waterproofing solutions for both new build and refurbishment of underground parking structures.

Contact your local Sika office for specific solutions for your project.



CAR PARK QUALITY CONCRETE PRODUCTION SOLUTIONS

In most modern developments reinforced concrete is used to form the foundations and below ground structure including any retaining walls. Additionally where steel would be too expensive or complex, reinforced concrete is also used for the structural framework of supporting columns, beams and the floor slabs – pretty much the whole of the overall building envelope. The importance of concrete quality and adequate performance specifications for what we know is an aggressive environment, wherever the parking structure is located, should not be underestimated.

The Sika solutions in this field include state-of-the-art concrete admixtures which are specifically designed to increase the concrete performance in terms of flow and compaction during placement and then to achieve higher strengths, increased watertightness and durability for a long service-life. Sika's local concrete experts will provide tailored bespoke solutions for design architects and engineers of parking structures. They work with their contractors and local concrete producers to create high performance concrete structures, including special surface effects as key visual design elements.

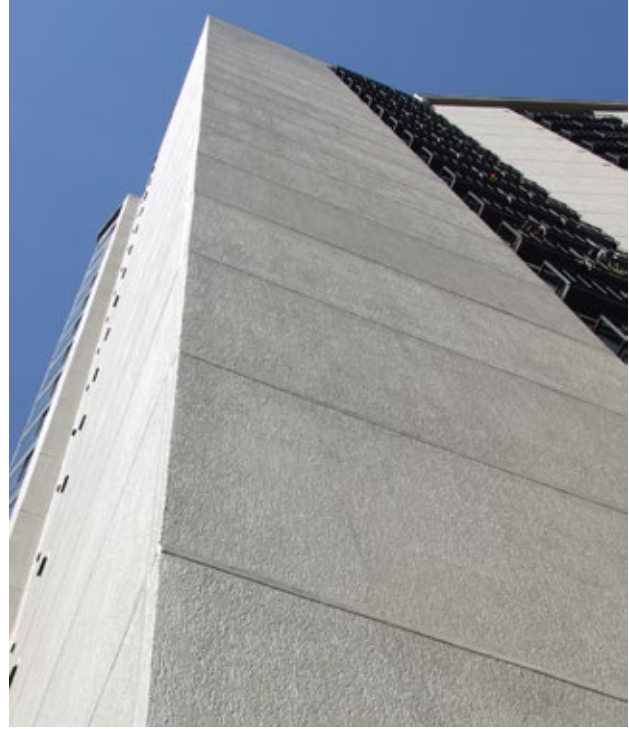

JOINT SEALING SOLUTIONS FOR FACADES AND PRECAST CONCRETE CONNECTIONS

Reliable watertight sealing of concrete movement, construction and connection joints is essential. These joint sealants do not only “fill the gaps” between concrete elements and other building materials or elements, their functions are much wider and more important. These joint sealants are used primarily to seal and waterproof these different forms of joint, and to connect similar or dissimilar elements in a flexible and accommodating way. This means that the materials must have excellent bonding properties to multiple substrates, maintain this and keep their flexibility for the long-term, whilst all the time being exposed to weathering and the environment of the location and the nature of the structures. So therefore including wide thermal variations, UV-light and de-icing salts to name just a few. Even after numerous contractions and expansions over many years they still have to prevent the ingress of water and aggressive pollutants into the structure. So would you specify and use “any old mastic” for this purpose on your structure – Best Not!

The requirements for excellent long term performance of joint sealant materials is obviously dependent on their use and exposure, e.g. type of joint, vertical or horizontal application, joint movement capability, mechanical and chemical resistance, trafficability, UV-light and color stability. The Sika range of joint sealing solutions is extensive and is designed to meet all of the joint sealing requirements in all types and areas of reinforced concrete parking structures.

CONCRETE REFURBISHMENT AND PROTECTION SYSTEMS



The prerequisite requirement for a car park flooring system is a sound concrete support structure and floor slabs. Therefore adequate monitoring and maintenance of the reinforced concrete is essential in order to ensure the designed service-life of both the protection systems and the structure itself. This includes:

- Protection of the embedded steel reinforcement
- Repair and/or replacement of any damaged and deteriorated concrete
- Protection of exposed concrete surfaces against mechanical, chemical and physical attack
- Strengthening of any areas or elements of the reinforced concrete structure that are unable to safely accommodate the anticipated static and dynamic loading

Successful concrete refurbishment starts with a detailed condition survey and assessment to identify the nature and extent of any damage, together with the root cause(s) of any degradation. It is only after this survey that assessment, of the appropriate repair and protection strategy and the best options for the repair and future protection works can be defined according to the relevant standards (e.g. European Standards EN 1504).

SIKA SOLUTIONS FOR THE REFURBISHMENT OF PARKING STRUCTURES

Sika has a full range of well-proven products and systems for all aspects of concrete refurbishment, including many innovative solutions that are ideal for use on parking structures, for example:

- Steel reinforcement protection
- High performance repair mortars
- Protective water repelling hydrophobic impregnations
- High performance protective and aesthetic surface coatings
- Penetrating
- Corrosion inhibitors
- Joint sealing and waterproofing systems
- Structural strengthening systems

Specific Sika innovations include: repair mortars that can be applied under dynamic loading, e.g. to soffits whilst the car deck above is in use; plus targeted penetrating inhibitors and impregnations to reduce water ingress and active corrosion on embedded steel reinforcement e.g. against chloride attack.

Sika produces a full range of products and systems for structural and non-structural concrete repair, which includes reinforcement corrosion protection, bonding primers for difficult substrates, repair mortars with special properties surface smoothing and levelling mortars for finishing and use in specific site conditions e.g. extreme temperatures and moisture content variations etc..



SIKA CONCRETE REPAIR SYSTEMS

For localised, non-structural concrete repair



Example of Sika repair system (R2)

- Reinforcement corrosion protection Sika MonoTop®-910 N/S
- Bonding primer (if necessary) Sika MonoTop®-910 N/S
- Repair mortar
- Sika MonoTop®-211 series
- Finishing mortar Sika MonoTop®-723 N

CHARACTERISTICS

- Class R2 repair system according to European Standard EN 1504-3
- One-component system
- Easy handling and application
- Accelerated setting for fast repair works (Sika MonoTop®-211 series)
- Repair mortar with corrosion inhibitors

For structural concrete repair



Example of Sika repair system (R3)

- Reinforcement corrosion protection Sika MonoTop®-910 N/S
- Bonding primer (if necessary) Sika MonoTop®-910 N/S
- Repair mortar Sika MonoTop®-352 series
- Finishing mortar Sika MonoTop®-723 N

CHARACTERISTICS

- Class R3 repair system according to European Standard EN 1504-3
- Easy handling and application
- Higher yield (lightweight repair mortar)
- Sulphate resistance
- Very low shrinkage behavior (Sika MonoTop®-352 series)

For structural concrete repair with demanding requirements



Example of Sika repair system (R4)

- Reinforcement corrosion protection SikaTop®-Armatec®-110 EpoCem®
- Bonding primer (if necessary) SikaTop®-Armatec®-110 EpoCem®
- Repair mortar Sika MonoTop®-412 series
- Finishing mortar Sikagard®-720 EpoCem®

CHARACTERISTICS

- Class R4 repair system according to European Standard EN 1504-3
- Designed for demanding concrete repairs
- For hand and wet spray application
- Proved for repair work under dynamic loads
- Sulphate resistance
- Very Low shrinkage behavior (Sika MonoTop®-412 series)

SIKA CONCRETE PROTECTION SYSTEMS



To prevent further damage to concrete structures due to water ingress, carbonation, chloride or other aggressive chemical influences concrete surfaces have to be protected. Sika produces a full range of surface applied corrosion inhibitors, impregnations, hydrophobic impregnations and specialist rigid or flexible crack-bridging, colored protective coatings, which are designed to provide the necessary protection for reinforced concrete surfaces. This includes all of the structural elements, facades, walls and soffits of parking structures.

Hydrophobic impregnation/ corrosion inhibitor



Surface applied corrosion Solution for standard requirements:

- Sika® FerroGard®-903 Plus

Hydrophobic impregnations for high protection requirements:

- Sikagard®-706 Thixo
- Sikagard®- 705 L
- Sikagard®- 730 Concrete Protect Plus

Hydrophobic impregnations for moderate protection requirements:

- Sikagard®-740 W
- Sikagard®-700 S

CHARACTERISTICS

- Unique, invisible protection system for steel bars and concrete surfaces
- High cost efficiency
- Easy to apply

Rigid protective coating systems



Solution for standard requirements:

- Sikagard®-675 W ElastoColor

Solution for high performance requirements:

- Sikagard®-680 S BetonColor
- Sikagard®-690 HD W

CHARACTERISTICS

- Complies with EN 1504-2
- Easy to apply
- Long term durability (Sikagard®-680 S & Sikagard®-690 W HD)
- Long-time experience

Elastic protective coating systems



System for moderate crack bridging requirements:

- Sikagard®-550 W Elastic

System for high crack bridging requirements:

- Sikagard®-545 W Elastofill plus, Sikagard®-550 W Elastic

CHARACTERISTICS

- Approved for low temperatures down to -20°C
- Water based system
- Good crack-bridging behavior
- Durable
- Long-term experience

Reactive resin protective coating system



Solution for high performance wall coating solution:

- Sikagard®-WallCoat WS-11

Waterborne Epoxy based, low emissions, high performance wall coating solution

- Sikagard® Wallcoat N

CHARACTERISTICS

- Complies with EN 1504-2
- Water based epoxy coating
- Low particle emissions
- Medium wear resistance
- Medium chemical resistance
- Smooth surface
- Easy cleaning
- Color options
- Low VOC

SIKA STRUCTURAL STRENGTHENING SYSTEMS



The Sika range provides the full range of carbon fibre reinforced polymer (CFRP) systems, including plates, fabrics, strings, anchors and pre-stressed/post-tensioned systems.

Sika pioneered the development and use of composite systems for structural strengthening, especially with carbon fibre (CFRP) and other fibres with structural epoxy and other resin adhesives. These are now widely used in parking structures for:

- Flexural strengthening of beams and slabs
- Shear strengthening of beams
- Increasing the axial, shear and flexural capacity of columns
- Seismic strengthening

Some of these innovative system characteristics and advantages include:

- Lightweight, easy to handle and quick to install with minimal downtime or closure
- More strength and capacity than traditional steel solutions
- Minimal additional volume or weight is added to the structure
- Ideal for difficult access areas and overhead application

Flexural strengthening

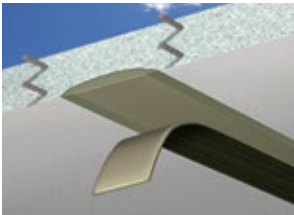

Sika strengthening solutions

- Carbon plate system Sikadur®-30 epoxy adhesive plus, Sika® CarboDur® carbon fiber reinforced plates (CFRP)
- Post-tensioning system Sikadur®-30 epoxy adhesives plus, Sika® CarboStress® (post-tensioning system)

CHARACTERISTICS

- High tensile strength
- No corroding
- Low weight
- Easy handling
- Limit deflection and cracks, increased fatigue resistance (post-tensioning system)

Shear strengthening

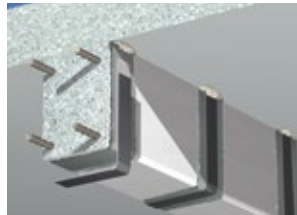

Sika strengthening solutions

- L-shape elements for beams Sikadur®-30 epoxy adhesive plus Sika® CarboShear prefabricated L-shape carbon fiber reinforced plates
- Fabric system Sikadur®-300/-330 epoxy adhesives plus SikaWrap® fabrics (carbon, glass)

CHARACTERISTICS

- High tensile strength
- Unique L-shape system for reduced on-site labour
- Low weight
- No corroding

Confinement strengthening

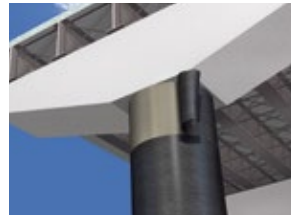

Sika strengthening solutions

- High performance confinement system Sikadur®-300/-330 epoxy adhesives plus SikaWrap® fabrics (carbon, glass)

CHARACTERISTICS

- Adjustable shape
- Easy application
- Increase axial capacity of columns
- Seismic strengthening

MEMBRANE WATERPROOFING SYSTEMS FOR PARKING STRUCTURES

SIKA PRODUCES SINGLE-PLY AND LIQUID APPLIED MEMBRANES designed for built-up parking deck and flat roofing systems, as well as thermal insulation and all of the required ancillary materials and accessories. More than 50 years of success in this field all around the world has now clearly documented that Sika parking deck and roof waterproofing solutions provide outstanding performance, with reliable, sustainable, and long-lasting results.

Current demand in the flat roofing segment is driven by the need for eco-friendly, energy-saving solutions such as green roof systems, cool roofs, and solar roofs, which can all simultaneously help to reduce CO₂ emissions. Whilst refurbishment projects continue to gain in significance for mature markets such as Europe, emerging markets elsewhere are still moving towards higher quality roofing solutions with complete Sika membrane system solutions. For parking structures, the Sika membrane systems are primarily used to meet the demand for ballasted or green roofs and utility roof decks where the top layer of the system build-up is also designed as a hard-wearing surface for pedestrian and / or vehicular traffic.

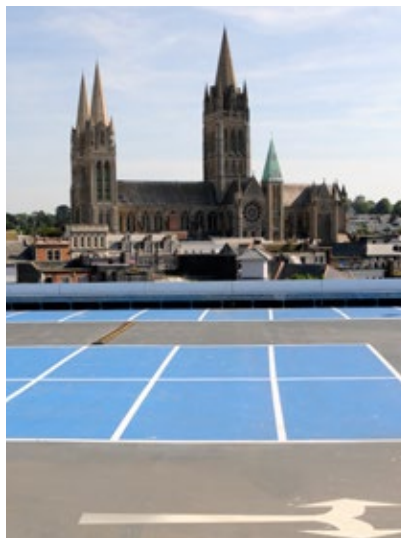

The Sika membrane systems are typically installed under concrete slabs, asphalt and Sikafloor® coating systems that are used to provide a secure and very long-lasting solution for useable roof decks. This type of utility roof deck is important on many projects because they can help to:

- Create more useable living space and bring additional value to the structure
- Generate an increased return on investment by using the roof for a car park, restaurant area or any other commercially viable purpose or facility

Utility roof decks share many features with gravel and green roof ballasted roof deck systems:

- The membrane is protected against any aggressive environmental exposure and mechanical damage
- The natural non-combustible properties of the paved wearing surface contribute significantly to the fire resistance of the roof and the building as a whole roof

LIQUID APPLIED ROOF DECK MEMBRANE SYSTEMS WITH Sikalastic®

Utility roof decks can also be waterproofed easily and securely with **Sikalastic®** liquid applied membrane systems that provides another unique range of solutions for utility roof decks:

- **Sikalastic®** top deck wearing surface layers can be used with added quartz sand and / or colored chips to give almost unlimited design possibilities for pedestrian terraces.
- Specific 2-C **Sikalastic®** products can be overlaid directly with hot poured asphalt, which can be a very cost effective solution to allow vehicular traffic access or provide additionally car parking areas

LOOSE LAID MEMBRANE SYSTEMS WITH Sikaplan® / Sarnafil®

- The **Sikaplan® / Sarnafil®** single ply membranes are loose laid on the substrate, welded together and then ballasted with the required utility deck build-up and wearing surface
- These **Sikaplan® / Sarnafil®** systems have a proven track record of over 30 years
- **Sikaplan® / Sarnafil®** membranes for utility roof decks easily resist biological influences and microorganisms attacks
- These flexible membranes can be installed in most weather conditions, even at minus temperatures
- No additional fastening is required and no invasive penetration of the roof deck is needed

All of the main advantages of liquid applied roofing membranes are also valid for utility roof decks:

- Cold applied waterproofing – no flames and no heating or welding required
- Seamless waterproofing, fully bonded to the substrate – preventing lateral water underflow
- The **SikaRoof® MTC** waterproofing layer is moisture and rain resistant just 10 minutes after application
- Most systems comprise 1-C products with a viscosity that is ideal for roofing applications (no need for any additional thinners or hardeners etc.)
- Easy installation with brushes and rollers even for complex surface shapes and detailing
- High tensile strength and crack bridging elasticity
- Long shelf life products

DECK COATING SYSTEMS MAINTENANCE INSTRUCTIONS



As covered elsewhere in this brochure, the deck waterproofing coatings for multi-storey car parks are exposed to many different thermal, mechanical and chemical stresses. The coating system must protect the concrete surface not only from potentially aggressive and damaging media such as water, chlorides, fuels, oils and battery acids, but also against the heavy mechanical loads and abrasive wear through being repeatedly driven over.

Also as mentioned previously there are increasingly high requirements for the parking decks appearance and aesthetics as well as their durability, which all have to be fulfilled. The regular care and maintenance of the coated deck surface is therefore also important to help preserve value and also to ensure the required long service-life. Addition-

ally, and especially in the cold and wet winter season, the adequate slip and skid resistance of the floor of the car park becomes a very important criteria, so the normal build-up of dust, dirt and pollutants must be frequently removed.

The intensity and the frequency of the cleaning regime and its intervals depends very much on the specific car park, its function, level of external exposure and weather conditions, the frequency of use, and the condition of the deck coating surfaces themselves.

The decision of whether each individual multi-storey car park must be cleaned daily, weekly, monthly or annually, can only be specified by the owners and their requirements, but it is recommended that these must all be made very clear to the operator to ensure

compliance. Generally the optimal cleaning regime can only be set up after a certain trial period for a full evaluation of the frequency required, the most appropriate cleaning machines, the right cleaning chemicals and procedures.

The selection of the right machines depends on the extent of the surfaces which have to be maintained and the spatial conditions (e.g. access and equipment storage heights, floor and slope/ramp gradients etc.). Therefore it is always best to seek advice from your local specialist floor cleaning companies or manufacturers of cleaning agents or/and equipment. Your local Sika office will be able to assist you with advice in this respect also as part of our comprehensive customer service.

SOLUTIONS FOR YOUR PROJECT IN A FEW CLICKS



WE PROVIDE INTEGRATED, FULLY COMPATIBLE SYSTEMS AND PRODUCTS for all of your various new build and refurbishment projects, from the basement to the roof, for buildings and civil engineering structures worldwide. Scan the QR code below to open our SikaSmart City – An online selection guide to find expert material solutions and references.

STEP 1: Select the project type in the SikaSmart city



STEP 2: Select the building element



STEP 3: Select the application



STEP 4: Review the search results

You will land on pages listing the corresponding Sika systems as options for the application you need. Here are some examples of such systems.

SYSTEMS FOR INTERMEDIATE DECKS IN CAR PARKS

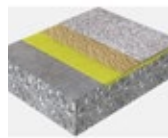

- BROADCAST, COLOURED, FLEXIBLE SCREED**
- Static crack-bridging properties, down to -10 °C
 - Coloured
 - Waterproof
 - Abrasion resistant
 - Meets German Standard OS 13

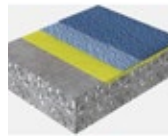

- BROADCAST, TOUGH-ELASTIC SCREED**
- Static crack-bridging properties
 - Waterproof
 - Abrasion resistant
 - Impact resistant

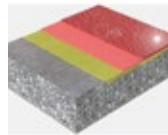

- BROADCAST, COLOURED RIGID SCREED**
- Waterproof
 - Abrasion resistant
 - Impact resistant



- BROADCAST, FAST CURING SCREED**
- Waterproof
 - Fast curing
 - Abrasion resistant

Please always visit your local Sika website to get your local solutions or contact our local sales and technical department to analyze your project situation and give you direct expert advice. Each project has its own requirements, and Sika's experienced engineers can help you make the right decision among the options.

ADDED VALUES FOR YOU:

- Standard or tailored CAD and 3D detailing drawings
- Standard or tailored BIM objects
- Onsite inspection and investigation
- Life cycle cost evaluation and comparison

ALSO AVAILABLE FROM SIKA



FOR MORE SIKA FLOORING INFORMATION:



WE ARE SIKA

Sika is a specialty chemicals company with a leading position in the development and production of systems and products for bonding, sealing, damping, reinforcing and protecting in the building sector and the motor vehicle industry. Sika's product lines feature concrete admixtures, mortars, sealants and adhesives, structural strengthening systems, industrial flooring as well as roofing and waterproofing systems.

Our most current General Sales Conditions shall apply. Please consult the most current local Product Data Sheet prior to any use.



SIKA SERVICES AG
Tueffenwies 16
CH-8048 Zurich
Switzerland

Contact
Phone +41 58 436 40 40
www.sika.ch

BUILDING TRUST

